	GLOBAL STANDARD	Page 1 of 63
	Remote Terminal Unit for MV/LV substation – UP2020 Lite	<b>GSTR002</b> Rev. 02 03/10/2019

## Remote Terminal Unit for MV/LV substation – UP2020 Lite

This document describes the UP2020 Lite equipment, the Remote Terminal Unit for telecontrol and supervision of Medium Voltage distribution network integrating an IEC 61850 Client; it provides functional and construction requirements for the provision.

Countries' I&N	Elaborated by	Collaborations by	Verified by	Approved by
Argentina	-	<b>Javier Bonaventura</b>	<b>Carlos Espinoza</b>	<b>Carlos Espinoza</b>
Brasil	-	<b>Kennedy Alves Martins</b>	<b>Darcio De Souza Dias</b>	<b>Darcio De Souza Dias</b>
Chile	-	-	<b>Daniel Gonzalez</b>	<b>Daniel Gonzalez</b>
Colombia	-	<b>Rincon Alvarez Cesar Augusto</b>	<b>Juan Gomez</b>	<b>Juan Gomez</b>
Iberia	<b>José Luis Calero Juan Miguel Gonzalez Provost</b>	-	<b>Maria Avery</b>	<b>Maria Avery</b>
Italy	<b>Stefano Riva Carla Marino</b>	<b>Domenico Demuro</b>	<b>Gianluca Sapienza</b>	<b>Gianluca Sapienza</b>
Peru	-	-	<b>Robert Sanchez</b>	<b>Robert Sanchez</b>
Romania	-	-	<b>Vasilica Obrejan</b>	<b>Vasilica Obrejan</b>

	Elaborated by	Collaborations by	Verified by	Approved by
<b>Global I&amp;N – NTI</b>	<b>Giorgio Scrosati</b>	<b>Michele Negro</b>	<b>Giorgio Scrosati</b>	<b>Fabio Giammanco</b>

This document is intellectual property of Enel Spa; reproduction or distribution of its contents in any way or by any means whatsoever is subject to the prior approval of the above mentioned company which will safeguard its rights under the civil and penal codes.

It is for internal Use. Each Country can provide a translation in local language but the official reference document is this GS English version.

Revision	Data	List of modifications
00	28.05.2018	First draft
01	06.06.2018	First approved draft for large area implementation in Italy
02	03.10.2019	Second approved editon.Includes the outcomes of the DtV – Design to Value – methodology

## INDEX

<b>1</b>	<b>ACRONYMS .....</b>	<b>5</b>
<b>2</b>	<b>NORMATIVE REFERENCES AND BIBLIOGRAPHY .....</b>	<b>6</b>
2.1	For all countries.....	6
2.2	For EU countries.....	7
2.3	For Iberia .....	7
<b>3</b>	<b>LIST OF COMPONENTS, PRODUCT FAMILY AND SOLUTIONS TO WHICH THE GS APPLIES .8</b>	
3.1	Components of the Remote terminal Unit for Secondary substation in the configurations available.....	8
3.2	Enel Product family codes of the components .....	8
<b>4</b>	<b>INTRODUCTION.....</b>	<b>10</b>
<b>5</b>	<b>TECHNICAL CHARACTERISTICS OF THE UE2020 LITE.....</b>	<b>12</b>
5.1	Construction characteristics .....	12
5.2	UE Functions .....	12
5.2.1	Chronological recording of fault current flows .....	12
5.2.2	Measurements .....	13
5.2.3	Faulty branch selection .....	13
5.2.4	Busbar voltage presence calculation (RVS).....	13
5.2.5	UP2020 I/O interface module function .....	13
5.2.6	Auxiliary functions .....	13
5.2.6.1.	Communication .....	13
5.2.6.2.	Diagnostics .....	14
5.2.6.3.	Date/time clock function.....	14
5.2.7	Configuration and Programming .....	14
5.2.7.1.	Configuration uploading.....	14
5.2.7.2.	Downloading of the firmware .....	15
5.2.8	Functionalities based on MQTT protocol .....	15
5.2.8.1.	DBR Automation .....	15
5.2.8.2.	Galileo Functionality.....	15
5.3	UE technical details.....	18
5.3.1	Cables.....	20
5.3.2	Connectors .....	20
5.3.3	Input terminals .....	20
5.3.4	Power supply .....	20
5.3.5	Remote controls.....	20
5.3.6	Remote signals .....	21
5.3.7	Measurements .....	22
5.3.8	Data buffering mode .....	23
5.3.9	Diagnostics .....	23
5.3.10	Features of the date-time clock.....	23
<b>6</b>	<b>TECHNICAL CHARACTERISTICS OF THE PSBC.....</b>	<b>24</b>
6.1	PSBC construction characteristics.....	24
6.2	PSBC electrical characteristics .....	24
6.3	Control of the mains, power supply and battery voltages .....	26
6.3.1	Test of the battery efficiency .....	26
6.3.2	Specification of the DCE power supply section.....	27
6.3.3	Configuration, signaling and protection devices.....	28
<b>7</b>	<b>COMMUNICATION PROTOCOLS AND TRANSMISSION EQUIPMENT.....</b>	<b>31</b>
7.1	IEC 60870-5-101 protocol.....	31
7.2	IEC 60870-5-104 protocol .....	32
7.3	Transmission equipment (DCE) .....	32
7.3.1	GSM/GPRS modem.....	33
7.3.1.1.	Physical interface to an external modem .....	33
7.3.1.2.	Data interchange with the modem .....	33
7.3.1.3.	Modem management.....	33
<b>8</b>	<b>TESTING AND INSPECTION.....</b>	<b>35</b>

	GLOBAL STANDARD	Page 3 of 63
	Remote Terminal Unit for MV/LV substation – UP2020 Lite	<b>GSTR002</b> Rev. 02 03/10/2019

<b>8.1</b>	<b>Overview of the tests required for the RTU and its components .....</b>	<b>35</b>
<b>8.2</b>	<b>Type tests .....</b>	<b>35</b>
8.2.1	Visual inspection .....	35
8.2.2	Tests of insulation and dielectric strength .....	35
8.2.3	Check of all of the functionalities .....	36
8.2.3.1.	UE .....	36
8.2.3.2.	PSBC .....	36
8.2.4	Stability check (PSBC only) .....	37
8.2.5	Electromagnetic compatibility tests .....	37
8.2.5.1.	UE .....	38
8.2.5.2.	PSBC .....	38
8.2.6	Thermal behavior test (PSBC only) .....	38
8.2.7	Climatic Tests .....	39
8.2.8	Mechanical tests .....	39
<b>8.3</b>	<b>Acceptance tests .....</b>	<b>40</b>
8.3.1	Preliminary checks .....	41
8.3.2	Functional check .....	41
8.3.3	Automatic Testing System (ATS) .....	42
<b>9</b>	<b>SUPPLY REQUIREMENTS .....</b>	<b>44</b>
<b>9.1</b>	<b>Voltage selector switch in the PSBC .....</b>	<b>44</b>
<b>9.2</b>	<b>TCA documents and Manuals .....</b>	<b>44</b>
9.2.1	TCA documents .....	44
9.2.2	Manuals .....	44
9.2.3	Safety warnings on Plate .....	44
<b>10</b>	<b>AMBIENT OPERATING CONDITIONS .....</b>	<b>44</b>
<b>11</b>	<b>ELECTROMAGNETIC COMPATIBILITY .....</b>	<b>45</b>
<b>11.1</b>	<b>Immunity requirements .....</b>	<b>45</b>
11.2	Emission limits .....	45
<b>12</b>	<b>SAFETY REQUIREMENTS .....</b>	<b>45</b>
<b>13</b>	<b>SOFTWARE .....</b>	<b>45</b>
13.1	Remote connection with the Center .....	45
13.2	Remote programming and configuration .....	45
13.3	Local programming and configuration .....	45
<b>14</b>	<b>GENERAL PRESCRIPTIONS .....</b>	<b>47</b>
<b>14.1</b>	<b>Reliability .....</b>	<b>47</b>
14.1.1	Normative references .....	47
14.1.2	Formulation of the reliability requirements .....	47
14.1.3	Verification tests of compliance with the declared failure rates .....	47
<b>14.2</b>	<b>Electronic Boards and components prescriptions .....</b>	<b>47</b>
<b>14.3</b>	<b>Project technical documentation .....</b>	<b>48</b>
<b>14.4</b>	<b>Spare parts .....</b>	<b>48</b>
<b>14.5</b>	<b>Equipment documentation .....</b>	<b>48</b>
<b>15</b>	<b>OPTIONAL SENSOR: NETTUNO .....</b>	<b>49</b>
15.1	Power supply .....	49
15.2	Operating .....	49
15.3	Connection .....	50

	GLOBAL STANDARD	Page 4 of 63
	Remote Terminal Unit for MV/LV substation – UP2020 Lite	<b>GSTR002</b> Rev. 02 03/10/2019

<b>15.4</b>	<b>Features.....</b>	<b>50</b>
<b>15.5</b>	<b>Installation.....</b>	<b>51</b>
<b>15.6</b>	<b>Reliability.....</b>	<b>51</b>
<b>15.7</b>	<b>Manual and accompanying documentation .....</b>	<b>51</b>
<b>15.8</b>	<b>Plate Data .....</b>	<b>51</b>
<b>16</b>	<b>APPENDIX .....</b>	<b>52</b>
<b>17</b>	<b>CYBERSECURITY PRESCRIPTIONS .....</b>	<b>63</b>

	GLOBAL STANDARD	Page 5 of 63
	Remote Terminal Unit for MV/LV substation – UP2020 Lite	<b>GSTR002</b> Rev. 02 03/10/2019

## 1 ACRONYMS

- **DCE** Data Circuit-terminating Equipment
- **DCS** Digital Cellular Service
- **DTE** Data Terminal Equipment
- **DFPI** Directional Fault Passage Indicator
- **FPI** Fault Passage Indicator
- **GS** Enel Global Standard
- **SD** Switch Disconnecter
- **SG** Switchgear
- **PSBC** Power supply/ battery charger of the RTU
- **PSTN** Public Switched Telephone Network
- **RGDAT** Enel standardized Directional fault passage and voltage loss indicator
- **RGDM** Advanced Fault Passage indicator with measuring acquisition
- **BVI** mains failure, Busbar Voltage Indicator
- **RC** Remote Control
- **RTU** Remote Terminal Unit
- **TM** Tele-Metering/Tele-Measurement
- **RS** Remote Signaling
- **TCA** Technical Conformity Assessment
- **TR** Transformer
- **UE** Processing Unit Device of the RTU
- **UP** Enel standardized Remote Terminal Unit for telecontrol and supervision of Medium Voltage distribution network

	GLOBAL STANDARD	Page 6 of 63
	Remote Terminal Unit for MV/LV substation – UP2020 Lite	<b>GSTR002</b> Rev. 02 03/10/2019

## 2 NORMATIVE REFERENCES AND BIBLIOGRAPHY

All the references in this GS are intended in the last revision or amendment.

### 2.1 For all countries

IEC 60068-2-1	Environmental testing - Part 2-1: Tests - Test A: Cold
IEC 60068-2-14	Environmental testing - Part 2-14: Tests - Test N: Change of temperature
IEC 60068-2-2	Environmental testing - Part 2-2: Tests - Test B: Dry heat
IEC 60068-2-6	Environmental testing - Part 2-6: Tests - Test Fc: Vibration (sinusoidal)
IEC 60068-2-64	Environmental testing - Part 2-64: Tests - Test Fh: Vibration, broadband random and guidance
IEC 60068-2-78	Environmental testing - Part 2-78: Tests - Test Cab: Damp heat, steady state
IEC 60255-27	Measuring relays and protection equipment - Part 27: Product safety requirements
IEC 61000-4-12	Electromagnetic compatibility (EMC) - Part 4-12: Testing and measurement techniques - Ring wave immunity test
IEC 61000-4-16	Electromagnetic compatibility (EMC) - Part 4-16: Testing and measurement techniques - Test for immunity to conducted, common mode disturbances in the frequency range 0 Hz to 150 kHz
IEC 61000-4-18	Electromagnetic compatibility (EMC) - Part 4-18: Testing and measurement techniques - Damped oscillatory wave immunity test
IEC 61000-4-2	Electromagnetic compatibility (EMC) - Part 4-2: Testing and measurement techniques - Electrostatic discharge immunity test
IEC 61000-4-29	Electromagnetic compatibility (EMC) - Part 4-29: Testing and measurement techniques - Voltage dips, short interruptions and voltage variations on d.c. input power port immunity tests
IEC 61000-4-3	Electromagnetic compatibility (EMC) - Part 4-3: Testing and measurement techniques - Radiated, radio-frequency, electromagnetic field immunity test
IEC 61000-4-3	Interpretation sheet 1 - Electromagnetic compatibility (EMC) - Part 4-3: Testing and measurement techniques - Radiated, radio-frequency, electromagnetic field immunity test
IEC 61000-4-4	Electromagnetic compatibility (EMC) - Part 4-4: Testing and measurement techniques - Electrical fast transient/burst immunity test
IEC 61000-4-5	Electromagnetic compatibility (EMC) - Part 4-5: Testing and measurement techniques - Surge immunity test
IEC 61000-4-6	Electromagnetic compatibility (EMC) - Part 4-6: Testing and measurement techniques - Immunity to conducted disturbances, induced by radio-frequency fields
IEC 61000-4-8	Electromagnetic compatibility (EMC) - Part 4-8: Testing and measurement techniques - Power frequency magnetic field immunity test
IEC 60332-3-10	Tests on electric and optical fibre cables under fire conditions
IEC 60870-5-101	Telecontrol equipment and systems - Part 5-101: Transmission protocols - Companion standard for basic telecontrol tasks
IEC 60870-5-104	Telecontrol equipment and systems - Part 5-104: Transmission protocols - Network access for IEC 60870-5-101 using standard transport profiles
IEC 60529	Degrees of protection provided by enclosures (IP code)
IEC 61000-6-4:	Electro-magnetic compatibility (EMC) - Part 6-4: Generic standards - Emission standard for industrial environments;
CISPR 32	Electromagnetic compatibility of multimedia equipment - Emission requirements

	GLOBAL STANDARD	Page 7 of 63
	Remote Terminal Unit for MV/LV substation – UP2020 Lite	<b>GSTR002</b> Rev. 02 03/10/2019

CISPR 11	Industrial, scientific, and medical (ISM) equipment - Radio frequency disturbance characteristics - Limits and methods of measurement
GSTR002	Remote Terminal Unit for MV/LV substation – UP2020 Lite
GSTR001/1	Remote Terminal Unit for secondary substations (UP)
GSTR001/2	UP - Box for indoor installations
GSTR001/3	UP - Box for Outdoor installations
GSCG002	Technical Conformity Assessment
GSCB001	12V Accumulators for remote control secondary substations
GSTP001	RGDAT-A70
GSTP011	RGDM Global Standard

## 2.2 For EU countries

EN 50160	Voltage characteristics of electricity supplied by public distribution systems
----------	--

## 2.3 For Iberia

R.D. 337/2014	Por el que se aprueban el Reglamento sobre condiciones técnicas y garantías de seguridad en instalaciones eléctricas de alta tensión y sus Instrucciones Técnicas Complementarias ITC-RAT 01 a 23.
---------------	--

	GLOBAL STANDARD	Page 8 of 63
	Remote Terminal Unit for MV/LV substation – UP2020 Lite	<b>GSTR002</b> Rev. 02 03/10/2019

### 3 LIST OF COMPONENTS, PRODUCT FAMILY AND SOLUTIONS TO WHICH THE GS APPLIES

#### 3.1 Components of the Remote terminal Unit for Secondary substation in the configurations available

The UP is available in different configurations, applicable to indoor and outdoor installations.

It consists of:

- a rack mounted processing unit device, namely UE
- a rack mounted power supply/battery charger, namely PSBC
- the cabinet, that can be suitable for indoor or outdoor installation

The UE and the PSBC are both suitable for installation to either indoor or outdoor cabinets and their characteristics are described in this specification.

The containers can have different shapes according to their applications. Their characteristics are described in the following Global Standards:

- UP Cabinet for Indoor installations: **GSTR001/2**
- UP Cabinet for Outdoor installations: **GSTR001/3**

#### 3.2 Enel Product family codes of the components

Global Product Family Code	Description	Reference Global Standard	Included in the Global Product family code
WM-UP2020 L8 Complete Kit	Complete UP2020 Lite kit for Indoor application, mounted in the Wall-mounted indoor cabinet container equipped with UE2020 L8	GSTR002 GSTR001/2	PSBC
			UE2020 L8
			WM-UP
WM-UP2020 L16 Complete Kit	Complete UP2020 Lite kit for Indoor application, mounted in the Wall-mounted indoor cabinet container equipped with UE2020 L16	GSTR002 GSTR001/2	PSBC
			UE2020 L16
			WM-UP
OS-UP2020Lite Complete Kit	Complete UP2020 Lite kit for Outdoor application, mounted in the Outdoor cabinet container equipped with UE2020 L8	GSTR002 GSTR001/3	PSBC
			UE2020 L8
			OS-UP
CM-UP2020Lite Complete Kit	Complete UP kit for Indoor application, mounted Ceiling mounted mounted in the Ceiling-mounted indoor cabinet container equipped with UE2020 L8	GSTR002 GSTR001/3	PSBC
			UE2020 L8
			CM-UP
PSBC	Power supply and battery charger	GSTR001/1	
UE2020 L8	Processing Unit Device capable to telecontrol for 8 switchgears	GSTR002	
UE2020 L16	Processing Unit Device capable to telecontrol for 16 switchgears	GSTR002	
CM-UP	Ceiling-mounted indoor cabinet container for Remote Terminal Unit	GSTR001/2	
WM-UP	Wall-mounted indoor cabinet container for indoor Remote Terminal Unit	GSTR001/2	
OS-UP	Outdoor cabinet container for pole-mounted Remote Terminal Unit - standard version	GSTR001/3	



	GLOBAL STANDARD	Page 9 of 63
	Remote Terminal Unit for MV/LV substation – UP2020 Lite	<b>GSTR002</b> Rev. 02 03/10/2019

OXL-UP	Outdoor cabinet container for pole-mounted Remote Terminal Unit - Extra-large version	GSTR001/3	
	Spare part: connection cable to the switch		
	Spare part: connection cable to the RGDAT		

**Table 1 – UP2020 Lite Global Product Family codes. The merchandise group for these items is FTTE0501<sup>1</sup>**

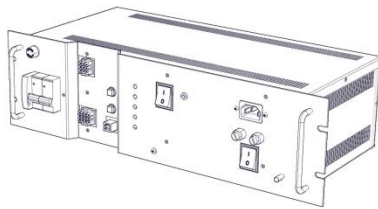

**Figure 1 – PSBC**

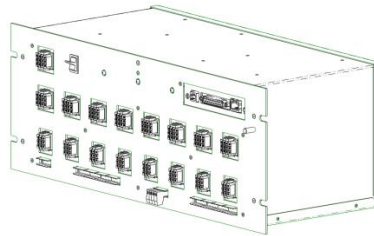

**Figure 2 – UE2020 L8**

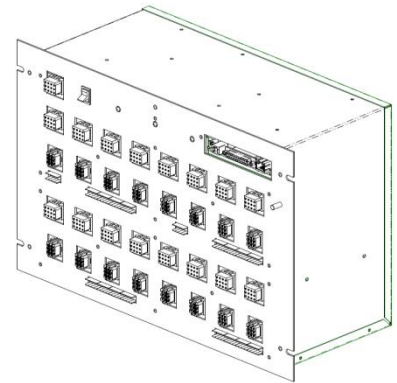

**Figure 3 – UE2020 L16**

The UE and the PSBC devices are equipped with the accessories provided in Table 2:

Accessories	Product family code	Device	Description	Included in the supply
<b>Cable connecting UE to PSBC</b>		UE2020 L8/UE2020 L16	The cable is composed of 11 conductors, with section 1,5mm <sup>2</sup> , terminating with two 12 pin loading connectors (see Figure 9).	Yes
<b>RS232 cable for DCE connection</b>		UE2020 L8/UE2020 L16	It is a DB9 Male/DB25 Female Modem Cable of length equal to 1.5m.	Yes
<b>Mains three pole plug</b>		PSBC	It is a three-pole plug (type IEC C13 according to IEC 60320 standard) for the termination of the cable (not included) of the AC power supply	Yes

**Table 2 - Accessories of the UE and PSBC devices**

<sup>1</sup> Please use this merchandise group when new local material codes are issued on the TAM system.

	GLOBAL STANDARD	Page 10 of 63
	Remote Terminal Unit for MV/LV substation – UP2020 Lite	<b>GSTR002</b> Rev. 02 03/10/2019

#### 4 INTRODUCTION

The *UP2020 Lite* equipment is an enhanced version of the RTU, consisting of all the functionalities and hardware requirements of UP 2015 Global RTU, but integrated with further software functionalities, detailed in this specification document.

For this reason the UP2020 Lite specification (GSTR002) is based on the UP2015 specification (GSTR001/1, rev.1) and most of its technical attachments continues to apply to UP2020 Lite.

Enel standardized MV remote control solution include a Remote Terminal Unit (RTU) and, optionally, as many fault detectors as the Line Out switches.

The components and elements of a MV/LV substation that can be remote controlled include MV and LV switch-disconnectors and circuit breakers. The Global Standard GSTR002 describe the standardized Remote Terminal Unit (RTU), also called UP, which can be used to remote control MV/LV substations, or to remote control pole mounted motorized switches. The UP is also the devices responsible to execute the self-healing distributed automation, when coupled with standardized fault detectors.

The central Remote Control System (Center, in the remainder) of the medium voltage distribution network is composed of:

- a Central Unit;
- a Front-end for communication with peripheral devices;
- Working Stations;
- etc.

The central unit is intended to perform the following functions:

- validation and transmission of the commands given by the operator to the Remote Terminal Units (RTU);
- acquisition, processing, and storage of data coming from the RTUs;
- selection of the faulty branches;
- configuration and remote diagnostics of the RTUs;
- Synchronization of the clocks of the RTUs.

This document describes the functions of the RTU devoted to medium voltage distribution network, and provides, nonetheless, the construction requirements for the provision.

The Center is capable to use all of the communication systems available on the market (public switched telephone networks, mobile networks, etc.), or those which can be implemented *ad hoc* (dedicated radio networks), which ensure messages transit times compatible with the System requirements.

The RTUs are expected to carry out the following functions:

- To communicate with the central system and ensure the forwarding to the field device of the remote controls received by the Center. A field device can be:
  - Medium Voltage Switch Disconnectors (SD), located in Secondary Substations or pole mounted
  - Medium Voltage Circuit-Breakers located in Secondary Substations or (SSCB) or pole mounted
  - Reclosers
  - Low Voltage motor-driven Circuit Breakers (LVCB) in the secondary substations (switchgears in their general acceptance);
- To detect the status of the switchgears and the diagnostics of each RTU, and make them available to the Center;
- To detect the fault signal from the fault passage indicators or protections (RGDAT/RGDM) that are installed in correspondence of the switches to be monitored, and subsequently store them with the date/time of occurrence, in order to make them available to the Central Unit;
- To implement automatic procedures for the selection of the faulty branches;

	GLOBAL STANDARD	Page 11 of 63
	Remote Terminal Unit for MV/LV substation – UP2020 Lite	<b>GSTR002</b> Rev. 02 03/10/2019

- To record field measurements (indoor temperature of the substation, currents, etc.), and make them available to the Center.

The RTUs can also be used as a part of MV/MV switching substations, where they remotely control the circuit breakers, and record the signals and measurements from the related protection and control panels.

	GLOBAL STANDARD	Page 12 of 63
	Remote Terminal Unit for MV/LV substation – UP2020 Lite	<b>GSTR002</b> Rev. 02 03/10/2019

## 5 TECHNICAL CHARACTERISTICS OF THE UE2020 LITE

### 5.1 Construction characteristics

The UE functional blocks must be designed as a chassis suitable for mounting onto a 19" normalized frame rack. The size of the chassis must be the following:

- a height equal to 4U, as to the UE2020 L8 version;
- a height equal to 7U, as to the UE2020 L16 version;
- a depth equal at most to 25 cm for both the UE2020 L8 and UE2020 L16 versions, according to the dimensions described in Figure 4.

The UE2020 L8 and UE2020 L16 devices are made of steel or an equivalent material in terms of electromagnetic compatibility and rigidity of the structure. They are supported only by the screws of the front panel. The UE must ensure at least an IP30 degree of protection (EN 60529).

Front panels must be provided with a 6MA grounding bolt.

### 5.2 UE Functions

The UE has to allow the execution of configurable actuation time commands, in order to remote control different types of existing switchgears (switch disconnectors, LV circuit breakers, reclosers, and MV circuit-breakers).

For each switchgear, the UE must record double permanent signals for its status (open and closed).

In the case of switched line\GSM channel communication between the UE and the central system:

- The UE must be capable to independently establish the connection with the Center (spontaneous calls), as a consequence of specific events previously configured or when analog measurements exceed preconfigured thresholds.

The Center must be capable to execute the spontaneous call by means of a remote command;

- The UE must manage a phone list consisting of three numbers to call in case of spontaneous call event.

Communication between the Center and the UE can also be permanent:

- on dedicated line, by using EC 60870-5-101 protocol;
- on IP network using IEC 60870-5-104 protocol and either the Ethernet port or the serial port (provided on the front).

The UE has to run the following monitoring functions related to the MV network operation:

- chronological recording of any event: this information must be accessible from local and remote access;
- measurements execution;
- faulty branch selection;
- auxiliary functions.

#### 5.2.1 Chronological recording of fault current flows

The UE has to chronologically record all the events with a precision of one thousandth of a second .

Chronological recording of fault current flows must be made available to the Central Unit, to be used:

- in real time, when permanent faults occur, for the selection of the faulty branch;
- in deferred time, to facilitate maintenance operations.

	GLOBAL STANDARD	Page 13 of 63
	Remote Terminal Unit for MV/LV substation – UP2020 Lite	<b>GSTR002</b> Rev. 02 03/10/2019

A special requirement regarding the logging function for ENDESA is provided as an external annex "RTU REMOTE ACCESS WITH VOYAGER SYSTEM".

## 5.2.2 Measurements

The UE is equipped with analogue inputs for the measurement of significant parameters of the secondary substation. A dedicated input for a PT100 sensing element must be provided in order to measure the ambient temperature.

## 5.2.3 Faulty branch selection

The UE must implement a series of local automatism. According to the status of given inputs, these automatism generate the opening and/or closing commands of the switchgears aimed at searching the faulty branch.

Upon the occurrence of well-defined events, or specific status transitions, the UE must be able to generate spontaneous calls toward the Center.

From the Center it has to be possible to individually disable each function related to spontaneous call and/or exclusion of the automatism, by means of remote commands.

The comprehensive description of all the automatism to be implemented in the UE is included in a specific confidential technical specification. The technical specification describing the Automatism will be delivered in its complete version only after the contract is awarded.

During the tender, only an extract is provided, being sufficient for a technical/economic assessment.

## 5.2.4 Busbar voltage presence calculation (RVS)

The UE must manage the presence of the busbar voltage for sending the signal to digital devices.

The calculation of this signal must be performed with these modes:

- if the RVS signal in the available remote signals is configured, the busbar voltage presence signal will be active when the RVS signal is also active
- if the RVS signal in the available remote signals is not configured, the bus voltage presence signal will be active when the "Mains failure / BVI" signal will not be active

## 5.2.5 UP2020 I/O interface module function

The UE must be able to behave as an input/output interface module for the UP2020.

The communication interface will take place via Ethernet port with IEC 60870-5-104 communication protocol.

It must be possible through the software to configure the following exclusive mode of operation.

The hardware configuration of the switchgears will take place by protocol through file transfers with json and binary files.

The automation cycles for the selection of the faulty branch must be performed locally.

## 5.2.6 Auxiliary functions

### 5.2.6.1. Communication

The Center has to be capable to communicate with the UE by means of all the following media:

- Switched Telephone Network (PSTN);
- 4-wire dedicated analog channels (4W Leased);
- GSM and DCS 1800 mobile network;
- IP networks;

	GLOBAL STANDARD	Page 14 of 63
	Remote Terminal Unit for MV/LV substation – UP2020 Lite	<b>GSTR002</b> Rev. 02 03/10/2019

- Satellite network;
- Radio network.

The device Hardware and software architecture must be flexible and easily allow the interchangeability among the above mentioned communication systems, as explained in the remainder.

#### 5.2.6.2. *Diagnostics*

The UE must include diagnostic functions of control, management, and local and remote reporting of anomalies in the operation of its functional parts.

#### 5.2.6.3. *Date/time clock function*

The UE must be equipped with an internal low drift and high resolution date/time clock.

All fault current detection or other system events must be stored in the internal buffer with a date/time stamp, according to a timing resolution of one thousandth of a second.

### 5.2.7 Configuration and Programming

It has to be possible to fully configure and program the UE either:

- locally, by means of a PC (not included in the supply), connected to the USB port
- remotely, via the DCE or the Ethernet network.

The UE configuration, either locally or remotely, is described into **Annex 1: “Remote Terminal Unit Configuration and Application Program Interface specifications”**.

**Annex 2: UE configuration parameters** contains the overall list of the UE configuration parameters.

**Annex 3: Remote Terminal Unit Protocols Specifications**, describes UP, the Remote Terminal Unit for telecontrol and supervision of Medium Voltage distribution network; it provides functional and construction requirements for the provision .

**Annex 4:** provides the list of the Information Object Addresses (IOAs), compliant with the IEC 60850-5-101/104 protocols, related to the signals, measurements, controls, statuses of the automatism stored into the UE database. Also a mapping between IEC 60850-5-101/104 and IEC 61850 protocols is provided.

The addition or modification of any record in the UE database must be possible by updating the device application firmware and reconfiguring it from the Center (i.e. local reconfiguration must not be required).

All of the user application software provided must meet the following requirements:

- Compatibility with OS Windows 7 and OS Windows 10 64 bit;
- Availability of “silent-mode” installation and update through Software Delivery.

A mobile application (ANDROID 4.2) must be also provided, useful to either configure the UE or update the firmware locally, by means of the UE USB port. In order to facilitate the user in the configuration via mobile, the application will be provided with a set of standard configurations.

All the interactions (configuration, visualization, firmware download and upload) between the software and the UE on the Ethernet port, must be performed encapsulated in secure protocol (latest version possible of SSH), and file transmission must be performed using SCP.

#### 5.2.7.1. *Configuration uploading*

The changing of any parameter must be made starting from the configuration setting which is in the UE in that moment, in order to avoid the risk of operating on outdated data.

	GLOBAL STANDARD	Page 15 of 63
	Remote Terminal Unit for MV/LV substation – UP2020 Lite	<b>GSTR002</b> Rev. 02 03/10/2019

As a consequence, at the beginning of each connection with the UE, the existing configuration must be uploaded, before proceeding with any local or remote configuration of the RTU.

#### 5.2.7.2. Downloading of the firmware

It must be possible to update locally the firmware of either the UE or the PSBC to the latest version (local downloading), through the same software used also for the configuration.

Nonetheless, it has also to be possible the remote download of the firmware for one or more UE (management of lists of devices). This operation may be executed either by the Center, by means of the same communication devices normally used for the remote control, or from a standard PC with a modem or LAN. For this purpose, a suitable software module must be provided, to be installed on a PC.

### 5.2.8 Functionalities based on MQTT protocol

UP2020 Lite must implement an MQTT Client and an MQTT Broker services. These services will be used to realize a peer-to-peer automation named “DBR”, and for publishing information (statuses and measures) from IoT sensors acquired by TCP ModBus.

While utilizing an instance of MQTT Client functionality, it will be necessary to configure at least the following parameters:

- Broker IP Address (MQTT Server where to publish messages)
- MQTT or MQTT over SSL mode
- MQTT TCP Port to be addresses (Default MQTT = 1883, Default MQTT over SSL = 8883)

#### 5.2.8.1. DBR Automation

UP2020 Lite must implement a new automation based on the exchange of communication between RTUs.

The principle of this automation is described in the attachment “*Automazione DBR - DSR per UP*”.

*Any UP participating to DBR is configured with at least the IP ADDRESS of the next UP (from the topological point of view) installed on the MV network, and the IP ADDRESS of the UP installed on the border of the feeder. DBR allows, thanks to the communication between UPs to manage remote open and remote close of other breakers, managed from remote UP.*

*The automation is fully described by the automations specification DX1220 ed.11 (latest revision). Some of the states are the trigger condition in order to publish messages to the “Next UP” or to the “Border UP” using MQTT protocol. The procedures requested at the subscription of a message is described in DX1220 ed.11 (latest revision) as well.*

#### 5.2.8.2. Galileo Functionality

UP2020 Lite must implement an application gateway for transmission to a specified central system (Server/Broker different from the SCADA system), of information collected by a series of sensors installed in the substation.

UP2020 Lite will acquire the information from the sensors by adopting TCP ModBus interface, this interface can be configured via a json file imported into the software.

UP2020 Lite will collect such information, store it locally (circular memory with the latest 500 messages), and publish it by adopting a particular topic to the configured MQTT Broker, adopting JSON payloads as exemplified below (real examples of messages recognized and accepted by the MQTT server for the GALILEO application):

	GLOBAL STANDARD	Page 16 of 63
	Remote Terminal Unit for MV/LV substation – UP2020 Lite	<b>GSTR002</b> Rev. 02 03/10/2019

***Payload 1 – Electric Measures Example***

```
{ "TS" : 1516188901179, "TCpu" : 44.01, "V1" : 225.53, "V2" : 225.88, "V3" : 226.33, "I1" : 21.40, "I2" : 25.10, "I3" : 11.20, "IN" : 18.40, "U1" : 390.65, "U2" : 392.00, "U3" : 391.22, "PA" : 8670.00, "PR" : 652.00, "Papp" : 13010.00, "F" : 50.00, "PF" : 0.67, "SPF" : 1, "EA" : 11491000.00, "ER" : 204000.00, "SPA" : 0, "SPR" : 0, "PEA" : 11491000.00, "PER" : 204000.00, "NEA" : 1000.00, "NER" : 425000.00, "PAmmedia" : 8816.00, "PA1" : 1784.00, "PA2" : 5484.00, "PA3" : 1402.00, "SPA1" : 0, "SPA2" : 0, "SPA3" : 0, "PR1" : 652.00, "PR2" : 0.00, "PR3" : 0.00, "SPR1" : 0, "SPR2" : 0, "SPR3" : 0, "PF1" : 0.37, "PF2" : 0.97, "PF3" : 0.55, "SPF1" : 1, "SPF2" : 1, "SPF3" : 1, "THDV1" : 1.50, "THDV2" : 1.30, "THDV3" : 1.40, "THDI1" : 40.00, "THDI2" : 14.10, "THDI3" : 0.00, "Iomopolare" : 0.00, "Q" : 1 }
```

***Payload 2 – Phasors Example***

```
{ "TS" : 1516188901179, "V1V2" : 240.40, "V2V3" : 239.90, "V3V1" : 239.70, "I1I2" : 215.20, "I2I3" : 32.60, "I3I1" : 112.20, "V1I1" : 18.10, "V2I2" : 0.00, "V3I3" : 0.00, "3ph" : 8.50 }
```

***Payload 3 – I1 Harmonics Example***

```
{ "TS" : 1516188901179, "HI1_1" : 1000.00, "HI1_3" : 40.00, "HI1_5" : 0.00, "HI1_7" : 0.00, "HI1_9" : 0.00, "HI1_11" : 0.00, "HI1_13" : 0.00, "HI1_15" : 0.00, "HI1_17" : 0.00, "HI1_19" : 0.00, "HI1_21" : 0.00, "Q" : 1 }
```

***Payload 4 – I2 Harmonics Example***

```
{ "TS" : 1516188901179, "HI2_1" : 1000.00, "HI2_3" : 0.00, "HI2_5" : 0.00, "HI2_7" : 0.00, "HI2_9" : 0.00, "HI2_11" : 0.00, "HI2_13" : 0.00, "HI2_15" : 0.00, "HI2_17" : 0.00, "HI2_19" : 0.00, "HI2_21" : 0.00, "Q" : 1 }
```

***Payload 5 – I3 Harmonics Example***

```
{ "TS" : 1516188901179, "HI3_1" : 0.00, "HI3_3" : 0.00, "HI3_5" : 0.00, "HI3_7" : 0.00, "HI3_9" : 0.00, "HI3_11" : 0.00, "HI3_13" : 0.00, "HI3_15" : 0.00, "HI3_17" : 0.00, "HI3_19" : 0.00, "HI3_21" : 0.00, "Q" : 1 }
```

***Payload 6 - V1 Harmonics Example***

```
{ "TS" : 1516188901179, "HV1_1" : 1000.00, "HV1_3" : 0.30, "HV1_5" : 0.80, "HV1_7" : 0.60, "HV1_9" : 0.10, "HV1_11" : 0.00, "HV1_13" : 0.00, "HV1_15" : 0.00, "HV1_17" : 0.00, "HV1_19" : 0.00, "HV1_21" : 0.00, "Q" : 1 }
```

***Payload 7 – V2 Harmonics Example***

```
{ "TS" : 1516188901179, "HV2_1" : 1000.00, "HV2_3" : 0.30, "HV2_5" : 0.70, "HV2_7" : 0.50, "HV2_9" : 0.10, "HV2_11" : 0.00, "HV2_13" : 0.00, "HV2_15" : 0.00, "HV2_17" : 0.00, "HV2_19" : 0.00, "HV2_21" : 0.00, "Q" : 1 }
```

***Payload 8 – V3 Harmonics Example***



	GLOBAL STANDARD	Page 17 of 63
	Remote Terminal Unit for MV/LV substation – UP2020 Lite	<b>GSTR002</b> Rev. 02 03/10/2019

```
{ "TS" : 1516188901179, "HV3_1" : 1000.00, "HV3_3" : 0.30, "HV3_5" : 0.60,
"HV3_7" : 0.60, "HV3_9" : 0.10, "HV3_11" : 0.10, "HV3_13" : 0.00, "HV3_15" :
0.00, "HV3_17" : 0.00, "HV3_19" : 0.00, "HV3_21" : 0.00, "Q" : 1 }
```

***Payload 9 – Environment Data Example***

```
{ "TS" : 1516188892376, "Reed1" : 1, "Reed2" : 1, "Tcavo1" : 9, "Tcavo2" : 10,
"Tcavo3" : 15, "Tcavo4" : 65409, "Tcab" : 0, "Hcab" : 0, "Ultrasioni1" :
753, "Ultrasioni2" : 4258, "Ultrasioni3" : 664, "Ultrasioni4" : 3870, "Ozono"
: 1000, "fumo" : 0 }
```

Each UP2020 Lite could retrieve "n" topics multiplied by the number of meters for payloads from 1 to 8 with a frequency of one every 60 seconds (configurable time from minimum 200 ms to maximum 60 minutes).

Payload 9 arrives every single minute (configurable time from a minimum of 10 seconds to a maximum of 60 minutes).

The data must be marked as sent / not sent to the Broker.

The data not sent must remain in non-volatile memory until the correct transmission to the Broker.

The topic to be published must be completely configurable, however a default of the following chaining should be proposed by the software:<sup>2</sup>

***Digitally/AREA\_CODICEMEPRCABINA/IDSENSORE***

To automatically propose the topic, among the configuration parameters of the MQTT Client the following fields should also be requested:

- **AREA** (2 char string), picklist from the following possibilities:
  - D1 Piemonte – Liguria - Sardegna
  - D2 Lombardia - Triveneto
  - D3 Emilia Romagna – Toscana - Umbria
  - D4 Lazio - Sicilia
  - D5 Marche – Abruzzo – Molise - Puglia
  - D6 Campania - Calabria
- **CODICE MEPR CABINA** (integer number with maximum 6 digit)
- **IDSENSORE** (integer number with maximum 2 digit)

---

<sup>2</sup> The values proposed may be different for each company. The json configuration file shall contain the values to be presented in the menu.

	GLOBAL STANDARD	Page 18 of 63
	Remote Terminal Unit for MV/LV substation – UP2020 Lite	<b>GSTR002</b> Rev. 02 03/10/2019

```

Digitally/LAM_PEPE_25777/4
04-05-2018 15:05:29.54329689
{
  "TS" : 1525439113895,
  "HV3_1" : 1000.0,
  "HV3_3" : 0.4,
  "HV3_5" : 2.0,
  "HV3_7" : 0.8,
  "HV3_9" : 0.0,
  "HV3_11" : 0.7,
  "HV3_13" : 0.3,
  "HV3_15" : 0.1,
  "HV3_17" : 0.0,
  "HV3_19" : 0.0,
  "HV3_21" : 0.0,
  "Q" : 1
}

```

**Figura 1 – Example of a correctly formatted topic and payload**

### 5.3 UE technical details

The UE is equipped with connectors and terminals, to interface with the controlled/monitored devices.

Two versions of the UE must be provided (UE2020 L8 and UE2020 L16), able to handle, respectively, 8 and 16 switchgears.

On the front, the UE2020 L8 version is equipped with:

- 8 female 12-socket connectors and 8 female 9-socket connectors (Figure 4), corresponding to the floating connectors utilized respectively on the switchgears and the fault passage indicators;
- 20 terminals for 10 Remote Signals (RSs):
  - 8 spare RSs;
  - 1 RS for substation door opening detection;
  - 1 RS for the transformer switch opening detection;
- 20 terminals for 9 Telemeasurements (TM):
  - 1 Telemeasurement of ambient temperature (Tamb- 4-wire PT100 sensing element);
  - 8 spare TMs.

The UE2020 L16 version is equipped on the front with:

- 16 female 12-socket connectors and 16 female 9-socket connectors (Figure 4), corresponding to the floating connectors respectively utilized on the switchgears and the fault passage indicators;
- 36 terminals for 18 Remote Signals (RSs):
  - 16 spare RSs;
  - 1 RS for substation door opening detection ;
  - 1 RS for the transformer switch opening detection.
- 20 terminals for 17 Telemeasurements (TM):
  - 1 Tele measuring of ambient temperature (Tamb- 4-wire PT100 sensing element);
  - 16 spare TMs.

The list of all of the signals, controls, telemesurements and digital outputs are provided in the Appendix.

	GLOBAL STANDARD	Page 19 of 63
	Remote Terminal Unit for MV/LV substation – UP2020 Lite	<b>GSTR002</b> Rev. 02 03/10/2019

Terminals must clamp conductors with an equivalent section of 1.5 mm<sup>2</sup>.

The digital outputs consist of an open collector PNP transistor, characterized by a maximum current equal 50mA. Each digital output, configurable as a “stable output” or “pulse output”, must be associated to the relative internal variable ISV (see GSTR001/1/A1 for details): ISV=1, high digital output; ISV=0, low digital output. In the case of RGDM or RGDAT, the digital output is utilized as “stable output” to control the inversion of the direction of the fault detection.

The UE is further equipped with:

- A Local/Remote-control rotary switch to enable devices installed in the secondary substation to local electrical control (in the L position) or to remote control (in the T position). It provides local indication and remote alarm to be sent to the Center. The selector also control the switch of the auxiliary supply, +A, from the + L to the +T position (see Figure 6).



**Figura 2 – Suggested Industrial Type rotary Local/Remote selector, suitable for glove handling.**

- 3 diagnostic LED;
  - 24 Vdc presence
  - Anomaly/Communication status
    - the communication status led shall indicate:
      - OFF: normal operativity
      - Slow flashing (once every two seconds): attempt for connection to the SCADA
      - Fast flashing(once every 500 ms): communication ONLINE
      - Always ON: Anomaly
  - fatal fault
- a reset button of the apparatus;
- a 2.0 USB interface for local programming;
- a DB25 RS232 connector for the DCE connection;
- a RJ45 Ethernet port; the default configuration must be:
  - IP Address            192.168.1.2
  - Subnet Mask        255.255.255.0
  - Default GW         192.168.1.1
- a female 12-socket connector for connection of the supply circuits (signal and supply).

The connection between the UE and the PSBC is performed via a multiple cable terminated at both ends with a floating 12-socket connector (of the same type as those used for the connection of the switchgears). The section of each cable must be equal to 1,5mm<sup>2</sup>, whereas the pinout is described in Table 19.

	GLOBAL STANDARD	Page 20 of 63
	Remote Terminal Unit for MV/LV substation – UP2020 Lite	<b>GSTR002</b> Rev. 02 03/10/2019

### 5.3.1 Cables

All the cables of the supply shall be compliant with IEC 60332-3-10:2018 (non-flame propagating).

### 5.3.2 Connectors

The coupling of the fixed and floating parts of each connector must be facilitated by polarization rails, and secured by elastic locking devices.

The connectors will be equipped only with the necessary contacts needed to perform the functions specified in the wiring diagrams.

The contacts used must have the characteristics shown below, while also considering the surface treatment and finishing:

- withstand voltage: 2kV<sub>AC</sub> -
- rated capacity 13A
- voltage drop on a male-female terminal pair, traversed by a 5 A current ≤ 50mV
- insertion-extraction force: 0,40 ÷ 10N/contact

The arrangement of connectors on the front of the UE (the provision shown in Figure 4 is only indicative) must allow the easy insertion and extraction of the connectors themselves.

If the connectors' plate is directly made by the printed circuit board, suitable reinforcements must be provided in order to allow the insertion and the extraction of the connectors without excessive bending of the plate itself.

### 5.3.3 Input terminals

The input terminals must clamp conductors with a diameter equal to 1.5 mm<sup>2</sup>.

### 5.3.4 Power supply

The UE is supplied by a 24V -15%, + 20% PSBC, which is described in **Chapter 6**.

The UE must be immunized against transient reductions of the supply voltage from 24V to 12V, for a 100ms time interval.

The UE must provide with a protection against the reverse polarity of the power supply wires.

The UE delivers the 24V<sub>DC</sub> power supply (by means of the pins +M and -M of the 12 socket connectors, see Figure 7) to all of the switchgears in connection with it. The internal conductors of the UE (either cables or patterns of the printed circuit boards), related to the power supply of the motors, must be of equivalent section not less than 2mm<sup>2</sup>.

### 5.3.5 Remote controls

Each command must be sent to the field by means of actuator relays with voltage free contacts.

The equivalent section and isolation of the conductive patterns and wires must be suitable to withstand a continuous current equal to 5A and a voltage equal to 110V; the relays must have the following characteristics:

	GLOBAL STANDARD	Page 21 of 63
	Remote Terminal Unit for MV/LV substation – UP2020 Lite	<b>GSTR002</b> Rev. 02 03/10/2019

- Rated current of the contacts: 5 A.
- Voltage Surge between coils and contacts: 3 kV.
- Limiting breaking capacity: 0.5A with time constant equal to 40ms.
- Electrical endurance:  $1 \times 10^5$  operations at the rated breaking capacity.

The ON time (output pulse length) of each output relay must be programmable at least between 0.1 and 2 seconds, in steps of 0.1 s.

The local/remote-control rotary switch, located on the front panel of the UE, must disable the actuator relays.

In the execution of an output command, a double safety check must be done.

In particular, the execution of a command must include three steps:

1. 1/N verification;
2. selection of the channel of the switchgear;
3. execution of the command.

To each step, the verification that it has been performed successfully has to follow. A single fault must not cause, in any case, the execution of unwanted commands.

The impedance value to be verified during the 1/N preparation step must be in the range of 5-5000 $\Omega$ . Outside of this range, the step is considered failed and the related alarm is generated.

**The execution of a control (double safety procedure included) must be performed within 30ms.**

### 5.3.6 Remote signals

UE2020 L8 and UE2020 L16 versions must be provided respectively with 49 and 89 digital input signals.

It has to be possible to configure each digital input of the UE, as either a simple or double signal, i.e. associated to the status of an additional digital input (as an example, the signaling of the open/closed position of the switchgears).

In addition, it has to be possible to configure:

- the idle status of the signal;
- the generation of an event associated to a signal;
- the type of event to be generated (“impulsive” or “status”);
- the generation of a spontaneous call to the Center;

It has to be also possible the configuration and tuning of the signals from the Center or using the remote configurator software.

Upon the occurrence of an alarm condition on one of these digital inputs, the UE sends spontaneously the information to the Center. To do so in case of GSM connection, in particular, the UE calls one of the three configured telephone numbers of the control Center.

Once the connection with the Center is established, the UE transfers a message, containing the status’s change that caused the spontaneous call.

If the above connection is not established correctly, the transmission attempts must be repeated until the UE receives confirmation of the regular reception of the message. The amount of attempts, and the time lapse between two consecutive attempts must be programmed remotely.

This is needed to prevent the transmission channels to be continuously busy, which would be incompatible with the proper operation of the network.

	GLOBAL STANDARD	Page 22 of 63
	Remote Terminal Unit for MV/LV substation – UP2020 Lite	<b>GSTR002</b> Rev. 02 03/10/2019

The spontaneous calls can be disabled via a remote control sent from the Center.

Each digital input of the UE will be provided with a debounce filter, which must be singularly programmable within the range of 10÷5000ms, with a step of 10ms.

The scan rate of all UE inputs must be equal to 10ms, in the worst case.

The events generated by the input signals (particularly those which are related to fault currents) must be stored in a circular buffer with a storage capacity of 1024 records at least. The data to be stored for each event generation pertain to the status of the digital input which generated the event, with associated date – time stamp of generation (according to an accuracy to the thousandth of a second).

### 5.3.7 Measurements

The analogue inputs (9 or 17 TM, depending upon the UE version) must be balanced-type, differential, insulated from any supply polarity and allow the reset of the measurement offset for each individual channel.

The UE acquires current signals, with the possibility to set two different scales:

**± 5 mA DC**

**4 ÷ 20mA DC.**

The analog measurement related to the temperature probe differs from the other analog inputs as the signal transducer is integrated in the UE itself. Furthermore, and only for this particular analog channel, it must be used a fixed codification, using the following linear characteristic:

Temperature	Codified value
-30°C	0 (zero)
+100°C	32767

Each analog input must be protected against overload from values which exceed 20% of the maximum value.

The resolution of the analog/digital conversion must be  $\geq 12$  bit (over the entire input range); the accuracy of the entire chain of conversion must be  $\leq 1\%$ .

The analog inputs must be sampled according to the following frequencies:

- at least once a second when there is a telemeasurement session on going;
- at least once per minute in the case of automatic monitoring (normal working condition with no telemeasurement session activated).

It must be possible the association of an alarm condition to one or more inputs when a minimum and/or maximum threshold limit has been exceeded. The exceeding of one of these limits must produce an event and manage it similarly to what happens for the digital inputs.

The telemeasurement session is activated in order to update the measurements displayed to the operator by the Center.

In the case of automatic monitoring, incoming data will be managed by the RTU, which will process and store the average values at intervals of 10 minutes (according to CEI EN 50160, §2.2). The stored average values will be transmitted to the Center upon specific interrogation.

Local memory areas must be included in the UE, so as to store the average values for a period of at least 2 weeks.

	GLOBAL STANDARD	Page 23 of 63
	Remote Terminal Unit for MV/LV substation – UP2020 Lite	<b>GSTR002</b> Rev. 02 03/10/2019

The measurement trends, downloaded by the Center via file transfer, must be organized in the format described in the GSTR001/1/A3.

### 5.3.8 Data buffering mode

The events generated by the UE have to be stored in different buffers, each related to a type of signal (SP Single Point, DP Double Point, etc...), according to a chronological order. Doing so, during the phase of data transfer to the Center, the response packets to the polling will contain the maximum amount of data (except for the last packet, for each type, whose size can be partial

The advantage of this data buffering mode is the minimization of the number of packets (and therefore of transmission time) required to transfer information to the Center. That applies especially when many heterogeneous event types are generated, which is the typical case of the automation cycles.

The correct chronological reconstruction of the events is the responsibility of the Center, utilizing the time-stamps associated with such events.

During the General Interrogation phase, the events are always sent by type, although, in this case, without the time-stamp.

### 5.3.9 Diagnostics

#### Communication and transmission

For the diagnosis of communication it is necessary to refer to the instructions listed in the standards CEI EN60870-5-101 and EN60870-5-104.

#### Hardware malfunctions

In case of hardware malfunctions detected by online diagnostics of the UE, appropriate error codes must be issued.

#### Local optical signaling

The UE must be provided with leds, which are placed on the front of the panel, showing:

- the presence of a 24 V<sub>DC</sub> power supply;
- RTU warnings/DCE communication status;
- RTU failure.

The UE must be provided with a reset button, as well.

#### Watch-dog circuit

The UE must be equipped with a watch-dog circuit for the automatic reset, in case the program execution is blocked.

### 5.3.10 Features of the date-time clock

The clock-calendar must have a resolution of one thousandth of a second and a maximum drift of less than 5 ppm, within a temperature range of -25 ÷ 85 °C, sufficient to ensure the right execution of all of the provided functions.

The synchronization must be carried out with a proper message, which is periodically sent by the Center; after this synchronization, the maximum residual misalignment must be less than 100ms.

In the reply message to the synchronization, the UE must return the couple date/time it had before the resynchronization, according to the CP56 Time2a format described in the specification CEI EN60870-5.

Upon UE startup, the clock and calendar must be initialized as follows:

- time        00:00:00,
- date        01/01/2000.

As an alternative the clock synchronization of the UP could be performed by means of NTP.

	GLOBAL STANDARD	Page 24 of 63
	Remote Terminal Unit for MV/LV substation – UP2020 Lite	<b>GSTR002</b> Rev. 02 03/10/2019

## 6 TECHNICAL CHARACTERISTICS OF THE PSBC

The PSBC charges the batteries which supply power to the components installed in the secondary substations or in the pole mounted installation:

- switchgears: motor driven switch disconnectors (SD), secondary substation/ pole mounted circuit-breakers , LV circuit breakers, reclosers;
- directional fault passage indicators (RGDM or RGDAT);
- UE;
- DCE.

### 6.1 PSBC construction characteristics

The PSBC functional block must be realized as a box panel suitable for mounting onto a 19” normalized frame rack.

The panel size must be:

- height equal to 3U;
- depth equal to 25 cm at most, in accordance to the dimensions reported in Figure 4.

The PSBC panel is made of steel, or an equivalent material in terms of electromagnetic compatibility and rigidity of the structure. It is supported only by the screws of the front panel. It must ensure a degree of protection IP30 (EN 60529).

The PSBC is also provided on the front with two handles, in order to facilitate the operations of assembly and disassembly from the cabinet container.

Side panels are provided with ventilation holes (Figure 4).

Front panel must be provided with a 6MA grounding bolt.

The PSBC must be provided on the front of a USB 2.0 port for the connection to a PC.

### 6.2 PSBC electrical characteristics

The power supply, whose circuit diagram is shown in Figure 5, must include:

1. a rectifier section
2. a battery charger section
3. an electronic card with functions of self-diagnosing and control of the power supply, as well as protection, switching, adjustment and signaling devices.

Under normal operating conditions, the PSBC will contribute to the supply of the UE and the auxiliary devices mentioned before (loads), and will keep the batteries charged.

In case of a loss or a temporary fault of the mains, the PSBC must provide the DC power supply, by means of the battery, until the system is restored to normal operating condition, preserving the loads from any power interruption.

The PSBC must be made up of:

1. a power isolation transformer, rated at 50 Hz/60 Hz (with a grounded electrostatic shield interposed between the primary and secondary windings),
2. a rectifier bridge with silicon diodes,
3. a circuit of adjustment and stabilization type “switching”
4. a decoupling diode from the battery.

In case of pole mounted installations, the input voltage of PSBC can be provided by a transformer having the following characteristics:

- Primary winding voltage: it depends on the MV nominal voltage of the involved network/country;



	GLOBAL STANDARD	Page 25 of 63
	Remote Terminal Unit for MV/LV substation – UP2020 Lite	<b>GSTR002</b> Rev. 02 03/10/2019

- Secondary winding voltage: 230 V<sub>AC</sub> or 100 V<sub>AC</sub>;
- Nominal power: 250 VA.
- Insulation voltage: 10 kV industrial frequency.

The choice between a 100V and 230V<sub>AC</sub> power supply must be made by means of a suitable selection switch, positioned at the rear of the PSBC. As default position, the power supply must be provided with the selector switch set to 230V<sub>AC</sub>. (see also **Chapter 9 SUPPLY REQUIREMENTS**)

The characteristics of the power supply must be the following:

- Rated Voltage:	100/230V <sub>AC</sub> .
- Voltage Range:	-10%÷20% of the rated voltage
- Rated frequency:	50/60Hz Compatibility with a 60Hz operation must be guaranteed.
- Rated output voltage:	24V <sub>DC</sub>
- Output voltage adjustment range:	23÷28V <sub>DC</sub>
- Maximum output current (fixed):	5A ± 5% (for varying values of the input voltage within the prescribed range)
- Efficiency:	≥ 75% ± 3% (at the maximum output current equal to 5 A and at the rated voltage equal to 24 V <sub>DC</sub> )
- Steady state stability (for simultaneous variations of the mains voltage from 90% to 120% of the rated voltage, under any loading condition from 0% to 100%):	±1%
- Dynamic state stability (for load steps of ¼, ½, ¾ of the maximum output current):	±5%
- Ripple at the maximum output current	±2%

The output voltage of the PSBC must be set (with regulating step of ±0,02V) equal to the rated voltage indicated by the battery manufacturer (normally 27.24V, equal to 2.27 V/cell, at 20 °C).

The PSBC must charge the absorbed electrolyte batteries. In this case, the value of the charging voltage must change automatically as a function of the value of the temperature assumed by the battery.

For this purpose, the PSBC must be equipped with a temperature probe (supplied with connection cable length equal to 0.5m without terminals interposition), to be placed near the batteries.

The voltage output must be modified according to this function:

	GLOBAL STANDARD	Page 26 of 63
	Remote Terminal Unit for MV/LV substation – UP2020 Lite	<b>GSTR002</b> Rev. 02 03/10/2019

$$V_{ch}(T) = (27.96 - 0,036T) \pm 1\%$$

Where, T is the measured temperature, in °C and  $V_{ch}$  is the charging voltage.

The ON and OFF switching of the rectifier with neither load nor battery must not lead to over voltages at the output exceeding 5% of the rated value.

All control and verification of the set values must be available via software.

### 6.3 Control of the mains, power supply and battery voltages

Mains power, battery voltage and all of the PSBC functionalities must be continuously monitored by means of electronic circuits, as described in the diagram of Figure 5.

These circuits must carry out the following functions:

- 1) Switch off the local signaling of "MAINS" and generate a remote alarm "Mains failure/BVI" when the supply voltage at 230 V<sub>AC</sub> ( $V_n$ ) takes a value  $\leq 20\%V_n \pm 10\%$  for a time interval  $\geq 200\text{ms} \pm 10\%$ . The previous alarm must be reset when the mains voltage reach a value  $\geq 80\%V_n \pm 10\%$  for a time interval  $\geq 250\text{ms} \pm 10\%$ . The mains voltage monitoring must be upstream of the fuses.
- 2) Generate an alarm, with local and remote signaling of "LOW V<sub>DC</sub>", when the battery voltage value is  $\leq 23.5\text{V} \pm 1\%$ , for a time interval of 30s  $\pm 10\%$ . The alarm is reset when the voltage assumes a value  $\geq 24,5\text{V} \pm 1\%$ . The "alarm" and "alarm reset" thresholds, as well as the duration of the debounce filter must be programmable, according to a range of 20÷30V<sub>DC</sub> with step of 0.1V, and a range of 0÷60s with step 1s, respectively.
- 3) Switch off the normally-on local signaling of "V<sub>DC</sub> ON" when the measured voltage has a value  $\leq 21.6\text{V} \pm 1\%$  for a time interval  $\geq 30\text{s} \pm 10\%$ , and disconnect all of the auxiliary circuits (by de-energizing the A relay – Figure 5). The maximum current consumption of the system, after the switch-off of the auxiliary circuits, must be  $\leq 50\text{mA}$ . The restoration process of the load is starting automatically when the battery voltage assumes a value of 22.8V $\pm 1\%$  and the led "V<sub>DC</sub> ON" is on.
- 4) Generate an alarm, with a local signal of "MAXIMUM V<sub>DC</sub>" and a remote signal of "RECTIFIER FAILURE", and disconnect (by setting the bistable B relay) from the mains supply when the output voltage on the rectifier (measured upstream of the decoupling diode) assumes a value  $\geq 29.1\text{V} \pm 10\%$  for a time interval  $\geq 5\text{s} \pm 10\%$ . The restoration of the mains supply must occur automatically, after 30 min  $\pm 10\%$ , while the restoration of the remote signal of "RECTIFIER FAILURE" must take place after 10 min  $\pm 10\%$  from the eventual successful restoration. The restoration must be also possible by means of the "RESET" button. Local signaling of "MAXIMUM V<sub>DC</sub>" must be restorable manually via "RESET" button only. The "alarm" and "alarm reset" thresholds, as well as the duration of the debounce filter must be programmable, according to a range of 25÷35V<sub>DC</sub> with step of 0.1V, and a range of 0÷60s with step 1s, respectively.
- 5) Generate a remote alarm of "RECTIFIER FAILURE" at the intervention of the 230 V<sub>AC</sub> power supply fuses.
- 6) Generate a local alarm of "BATTERY FAILURE" and enable the remote signal of "Battery Fail", when the efficiency test of the battery fails. This alarm must be reset manually, using the reset button "RESET" only.

#### 6.3.1 Test of the battery efficiency

A circuit must provide the verification of the battery efficiency; it must be activated by a configurable timer inside the power supply, and a "BATTERY TEST" button on the front of the power supply. During the test run, the "BATTERY FAILURE" LED, located on the front panel, must blink.

The test must reduce the power supply output voltage to an appropriate level, and perform a discharge of the battery by supplying a resistive load of 13.5 ohms, for a maximum time interval of 15 min  $\pm 10\%$ .

The test must not cause any alarm issue (LOW  $V_{DC}$ , RECTIFIER FAILURE, etc.) if it is successful.

The threshold voltage ( $V_{threshold}$ ) used to discriminate the outcome of the test must be programmable via software from 22.45 to 25  $V_{DC}$  (according to a step equal to 0.05), and It must have a default value equal to 23.75V.

The test must run periodically (with a programmable frequency, set by default to "weekly") and must be excluded via software. An internal log in the PSBC shall record the time and date of the last 30 tests and the relative result (POSITIVE or FAIL).

### 6.3.2 Specification of the DCE power supply section

The PSBC has to be capable to supply the DCE with a 12V DC  $\pm 10\%$  direct current power output, isolated from the UE power supply (24V with grounded positive terminal) through the interposition of a DC/DC converter with a supply capacity of at least 8W with no interruption.

The DCE power supply section must comply with the following characteristics (which are typical of the GSM type DCE used by ENEL):

Condition	Value	Effect
Minimum voltage	900/1800MHz < 8V <sub>DC</sub>	Operation is not guaranteed
Maximum voltage	900/1800MHz > 36V <sub>DC</sub>	Overvoltage protections are triggered

**Table 3 - Absolute Limits**

A fuse positioned on the supply cable guarantees the permanent overvoltage protection.

Parameters	GSM 900			DCS 1800			Unit
	Min.	Typ.	Max	Min.	Typ.	Max.	
Supply voltage	9,6	12	28.8	9,6	12	28.8	V <sub>DC</sub>
Peak current			2,5			1	A

**Table 4 - Operating Limits**

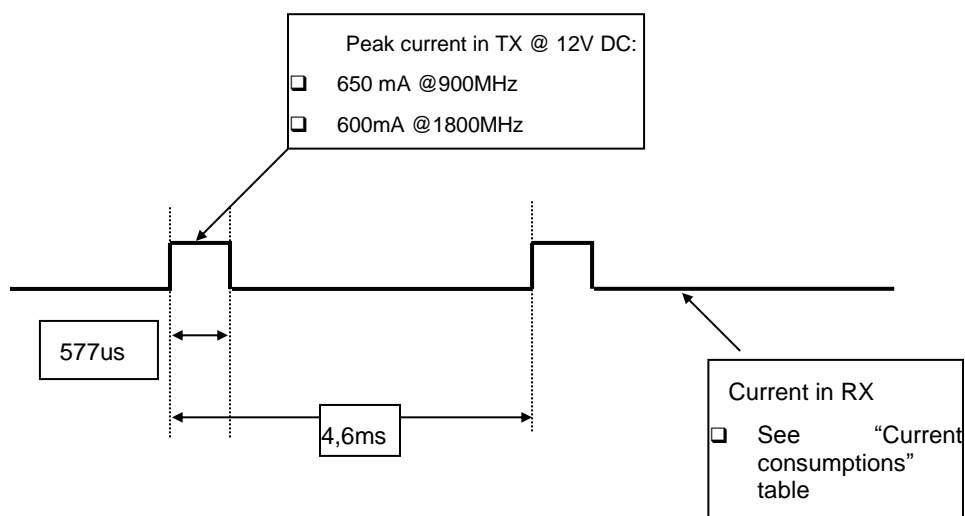

**Peak current diagram**

In case of 2G/3G modules the constraints are the followings:

- Voltage range: 9.6 to 30 VDC; max ripple of  $\pm 10\%$ ;
- Maximum power absorbed in all conditions:  $\leq 8\text{ W}$ , excluding instantaneous peaks;
- Instantaneous peak absorptions: within the limits specified by the following Table 5.

Supply voltage	Average current in RX	Average current in TX (GSM900)	Average current in TX (DCS1800)
9,6V	80mA	310mA	230mA
12V	65mA	250mA	180mA
19,2V	40mA	150mA	110mA
24V	35mA	120mA	90mA
28.8V	30mA	100mA	75mA

**Table 5 - Current Consumption**

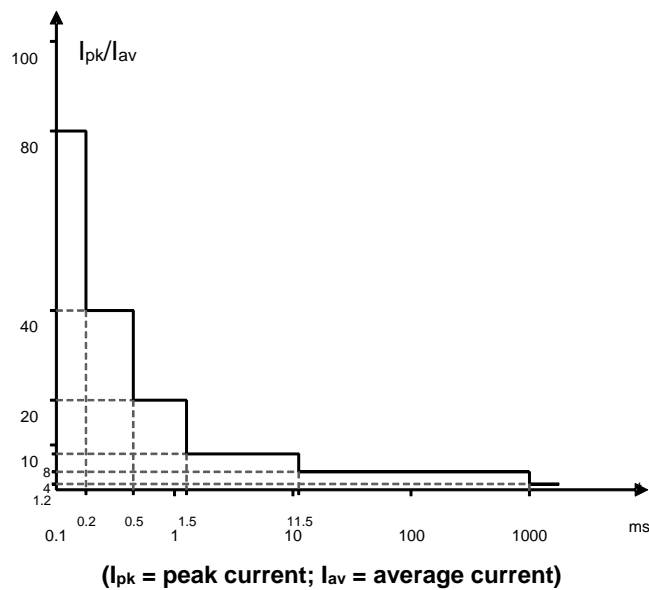

DCE module can be also supplied directly by 24V<sub>DC</sub>; in this case DCE must be compliant with grounded positive pole of battery section.

### 6.3.3 Configuration, signaling and protection devices.

On the front of the panel, as shown in Figure 4 the following items are mandatory:

- n°5 LEDs for the local signaling of:
  - MAINS, green led (relay 27);
  - V<sub>DC</sub> ON, green led (relay A);
  - LOW V<sub>DC</sub>, red led (relay 80);
  - MAXIMUM V<sub>DC</sub>, red led (relay 45);
  - BATTERY FAILURE, red led;
- a button (RESET) to restore the operation of the PSBC;
- a BATTERY TEST button to activate the test;

	GLOBAL STANDARD	Page 29 of 63
	Remote Terminal Unit for MV/LV substation – UP2020 Lite	<b>GSTR002</b> Rev. 02 03/10/2019

- a disconnecter and delayed fuses (phase and neutral) on the 230 V<sub>AC</sub> power supply, with the following characteristics:
  - rated voltage: 230 V<sub>AC</sub>
  - rated current (disconnecter): ≥5 A
  - rated current (fuse): 2,5 A;
- a delayed fuse on the output (negative terminal) towards the battery, with the following characteristics:
  - rated voltage: 24 V
  - rated current: 20 A;
- a bipolar circuit breaker (42-M), compliant with the Standard IEC 60947-2, with the following characteristics:
  - rated operating voltage: 24V
  - rated current (disconnecter): 20A
  - tripping curve: C
  - breaking capacity ≥4,5 kA
  - opposite auxiliary contact 1 A at 24 V<sub>DC</sub>

The opposite auxiliary contact will be used to send the remote alarm signal of "MOTOR FAILURE";

- a bipolar switch (42-l) with the following characteristics:
  - rated operating voltage: 24 V<sub>DC</sub>
  - rated current: 2 A
  - breaking capacity: 2,5 kA;
- a 12 socket connector for the exchange of the circuits with the UE (Table 19);
- a 9 socket connector (Table 20) for the connection to the batteries and the terminal board of the RTU cabinet container;
- a three-pole plug for the AC power supply input (connector type IEC C13 according to IEC 60320 standard).

**The three-pole plug for the termination of the cable of the AC power supply is included in the supply.**

Instead of a conventional fuse, the PTC thermistor (Figure 5) must be used to protect the auxiliary electronic circuits against over currents.

A switch must be placed at the rear of the power supply, for the selection of the AC voltage (100V/230 V) of the power supply.

The internal power supply connections must be chosen so as to avoid that the conductors can assume temperatures that exceed the set thresholds.

The wires must be N07V-K type according to CENELEC HD361:

- Insulation voltage U<sub>0</sub>/U equal to 450/750V;
- Material: common PVC;
- Flexibility: flexible for stable installations, according to class 5 – IEC 228);

	GLOBAL STANDARD	Page 30 of 63
	Remote Terminal Unit for MV/LV substation – UP2020 Lite	<b>GSTR002</b> Rev. 02 03/10/2019

having non propagating fire characteristics, in compliance with IEC 60332-3 or CEI 20-22 (Italy only).

All connections should be marked with a collar marked with the reference to the corresponding terminal.

In particular, the connections to the battery poles, red for the positive and black for the negative, must have: a section  $\geq 3\text{mm}^2$  ( $2 \times 1,5\text{ mm}^2$ ), a length  $\geq 80\text{cm}$  and, on the battery side, a collar label indicating the respective polarity. The ends of the connection to the battery poles must be left unterminated (properly isolated one to the others and to the earth). They will be terminated at the moment of the battery installation.

	GLOBAL STANDARD	Page 31 of 63
	Remote Terminal Unit for MV/LV substation – UP2020 Lite	<b>GSTR002</b> Rev. 02 03/10/2019

## 7 COMMUNICATION PROTOCOLS AND TRANSMISSION EQUIPMENT

A detailed description of the communication protocols “profiles” is provided in a dedicated annex, accordingly to the destination Country. the document GSTR001/1/A3 (further details will be delivered after the tender has been awarded).

Just an high level, general description regarding the required communication protocols is recalled below, sufficient for a technical/economic evaluation of the topic.

The RTU must be able to communicate with the Center by adopting one of the two following communication standards:

- IEC 60870-5-101, to the serial RS232 port;
- IEC 60870-5-104, to the Ethernet or serial RS232 port.

**The RTU must also be able to communicate with IEC 61850 Servers (IEDs) in the Local Area Network by implementing an IEC 61850 Client**, on the Ethernet Port. The details regarding data exchange between IEDs and UP2020 Lite, and the data gateway functionality between IEC 61850 and IEC 60870-5-101 or IEC 60870-5-104 are described in the technical attachments to this specification (GSTR002\_A4-IOA IEC\_DB (REV1) UP2020 Lite.xlsx).

IEC61850 will be an alternative method to interface with IEDs such RGDM. UP2020 Lite will be able to interface both wired RGDM and IEC 61850 RGDM or other servers, and continue to provide the same remote control and automation functionalities.

### 7.1 IEC 60870-5-101 protocol

It is mandatory to refer to the profile detailed in the IEC 870-5-101 standard [profile structured according to three OSI layers: 7 (Application), 2 (Data-Link) e 1 (Physical)] for the "unbalanced transmission mode" and in compliance with the following clarifications/changes/additions:

#### Level 1:

The RTU uses the following transmission networks:

- GSM 900 network;
- DCS - 1800 network;
- PSTN network;
- Direct interconnection to dedicated circuits (4W Leased Line);
- Radio;
- Satellite network.

The DTE (RTU) must interface with these transmission networks by means of a physical interface to an external modem (external DCE).

In the case of PSTN, GSM, and 1800 DCS networks, a mechanism for connection restoration (with relating time-out) is provided, in case the line falls down.

#### Level 2:

- The Center and the RTU will respectively play the role of “Master” and “Slave”;
- the address field must consist of two octets;
- the “single control character” must not be used;
- In the case of GSM/DCS and PSTN transmission networks:
  - the parity bit of each character of 11 bits must be omitted (violation of the rule R2, each character will then be composed of 10 bits) with the activation of:

	GLOBAL STANDARD	Page 32 of 63
	Remote Terminal Unit for MV/LV substation – UP2020 Lite	<b>GSTR002</b> Rev. 02 03/10/2019

- in case of GSM/DCS, a “non-transparent” data transmission mode;
  - in case of PSTN, a V.42 error correction;
  - o starting idle character must be omitted (violation of the rule R1);
  - o During data reception, there must be discontinuity between the characters of the same frame (inter-character time window), according to the typical time-out of the GSM/DCS and PSTN transmission networks, as a function of the set out conditions of use.
- In the case of spontaneous call (level 1) of the RTU, the "Master" launches an identification procedure for the recognition of the "Slave" and the subsequent start of data exchange;
  - The standard time-outs provided are valid starting from the validation time of the physical connection (level 1).

#### Level 7:

- The application protocol must be implemented according to the instructions provided in the standard and according to the interoperability profile inside the reference document;
- the chosen subset of messages, selected from the overall set provided in the standard, supports the implementation of the application activities, as illustrated in the reference document;

## 7.2 IEC 60870-5-104 protocol

For the management of the IEC 60870-5-104 protocol, different alternative methods of communication can be adopted, by means of local configuration:

1. communication via Ethernet port, or
2. communication via modem GPRS on RS232 serial port.

In the case 2, the RTU can be configured with TCP/IP and PPP protocol management. In this case, the GPRS modem is used as a simple transmission medium adapter (ISO/OSI level 1): the RTU must manage any upper ISO/OSI layer.

#### Level 1:

The RTU apparatus utilizes the following transmission networks:

- IP Ethernet network;
- GPRS network;

See the transmission equipment paragraph for further information.

#### Level 2:

- The Center and the RTU will respectively play the role of “Master” and “Slave”;
- the address field must consist of two or three octets (in according to the interoperability profile) ;
- the “single control character” must not be used;
- The time-out provided in the standard are valid starting from the validation time of the physical connection (level 1).

#### Level 7:

- The application protocol must be implemented according to the instructions documented in the standard and according to the interoperability profile as inside the reference document;
- the chosen subset of messages, selected from the overall set as detailed in the standard, supports the implementation of the application activities, as illustrated in the reference document;

## 7.3 Transmission equipment (DCE)

The RTU must be able to communicate with the Center via various means of communication (switched fixed telephone networks, 4-wire dedicated fixed telephone links, 900 MHz GSM networks or 1800 MHz DCS networks, radio networks, etc.). For each of the above mentioned systems, it might be necessary to adopt a different type of DCE. The RTUs must be implemented in order to make the DCE interchangeability



	GLOBAL STANDARD	Page 33 of 63
	Remote Terminal Unit for MV/LV substation – UP2020 Lite	<b>GSTR002</b> Rev. 02 03/10/2019

as easy as possible; for this reason, the UE local reconfiguration actions, for varying items of the adopted DCE, must be minimized, or rather, reduced to zero. All of the tools which are useful to ENEL in order to interface the apparatus with the DCE of the latest generation must be made available.

### 7.3.1 GSM/GPRS modem

#### 7.3.1.1. Physical interface to an external modem

The physical interface for the connection to an external modem must include the following features:

- Type: ITU-T V.24/V.28;
- Connector: ISO 2110, D type, 25-pole, male;
- Managed interchange circuits: see Appendix.

#### 7.3.1.2. Data interchange with the modem

The data interchange between the RTU and the modem must comply the following instructions:

- Transmission rate of reference data: 9600bps; nonetheless, the RTU must be designed to operate at higher speeds also, up to a maximum of 115.2 kbps, whereas other transmission systems and technologies are able to support them.
- Data format: asynchronous transfer mode, 1 start bit, 8 bit data, no parity bit, 1 stop bit.
- Flow control: software, by using DC1 – DC3 (XON - XOFF) characters, and hardware, by using C.106 (CTS) and C.105 (RTS) circuits.

#### 7.3.1.3. Modem management

Modem functionalities must be handled by the RTU according to a standard mode:

- AT issues (GSM 07.05, GSM 07.07, V.25ter);
- V.25bis.

The DCE GSM/DCS connection cable, which is always included in the supply of each UE, must be at least 2m long, and must include the following:

- a D25 type connector, female poles, on the RTU side;
- a D9 type connector, male poles, on the GSM modem side.

To the modem (9 pin type D Male)		To the RTU (25 pin type D female)	
Pin	Signal denomination	Signal denomination	Pin
3	103	103	2
2	104	104	3
7	105	105	4
8	106	106	5
6	107	107	6
5	102	102	7
1	109	109	8
4	108	108	20
9	125	125	22

**Table 6 – Signal pinouts between DTE and DCE, in the case of use of GPS/GPRS Modem**

	GLOBAL STANDARD	Page 34 of 63
	Remote Terminal Unit for MV/LV substation – UP2020 Lite	<b>GSTR002</b> Rev. 02 03/10/2019

The DCE connection cable must have a length equal to at least 1m, and it must be equipped with the following connectors:

- a D25 type connector, female poles, on the RTU side;
- a D25 type connector, male poles, on the PSTN Modem side.

The DCE (PSTN type) connection cable must be provided as long as it is requested in the related order.

To the modem (25 pin type D Male)		To the RTU (25 pin type D Female)	
Pin	Signal Denomination	Signal Denomination	Pin
2	103	103	2
3	104	104	3
4	105	105	4
5	106	106	5
6	107	107	6
7	102	102	7
8	109	109	8
9	+ V <sub>DC</sub>	+ V <sub>DC</sub>	9
10	- V <sub>DC</sub>	- V <sub>DC</sub>	10
15	114	114	15
17	115	115	17
18	141	141	18
20	108	108	20
21	140	140	21
22	125	125	22
24	113	113	24
25	142	142	25

**Table 7 Signal pinouts between DTE and DCE, in the case of use of PSTN Modem**

	GLOBAL STANDARD	Page 35 of 63
	Remote Terminal Unit for MV/LV substation – UP2020 Lite	<b>GSTR002</b> Rev. 02 03/10/2019

## 8 TESTING AND INSPECTION

The testing and certification process for the UP and its components must be executed according to Enel Global Standard **GSCG002 - Technical Conformity Assessment**. That Global Standard describes the procedures for “technical conformity assessment” (hereinafter “TCA”) of components to be supplied (directly or indirectly) to all Enel Global Infrastructure and Networks Countries.

Before starting the supply, the UP and its components must receive the “Statement of Conformity”, according to GSCG002 prescriptions.

### 8.1 Overview of the tests required for the RTU and its components

The following tests must be executed onto each component (UE e PSBC) of the RTU:

1. Visual examination
2. Isolation and dielectric strength tests
3. Checking of all the functions
4. Voltage Stability Check (PSBC only)
5. Electromagnetic compatibility tests
6. Thermal behavior tests
7. Mechanical compatibility tests
8. Climate compatibility tests

The above listed tests must be performed in Accredited Laboratories according to the current standards.

The supplier must retain all the documentation proving the successful results of the type tests and all data must be made available to ENEL in real time.

At ENEL’s discretion, these tests may be completely or partially repeated during the lifetime of the contract as continuing evidence of type conformity.

Testing procedures can be classified in:

- a) type test, with the aim to verify the perfect compliance of a production specimen with the technical specifications detailed in the present document;
- b) acceptance test, with the aim to control the essential characteristics of each device of the supply.

### 8.2 Type tests

The type tests are comprehensive of those which are indicated in the previous paragraph (1 through 8), including the software tests that are used for the calibrations and check of the various thresholds.

The supplier must keep and provide ENEL access to the documentation which attests to the success of the execution of the type tests.

#### 8.2.1 Visual inspection

It is mandatory to verify the absence of visible manufacturing defects, the accuracy of construction, the compliance of the materials and treatments required, the dimensions of all of the RTU components with those indicated in the current specification as well as the prescribed degree of protection.

An appropriate inspection must be performed on the power connectors, in order to verify that the insulating parts were manufactured well.

#### 8.2.2 Tests of insulation and dielectric strength

The aim of the tests is to verify the dielectric strength amongst the independent circuits of the power supply.

	GLOBAL STANDARD	Page 36 of 63
	Remote Terminal Unit for MV/LV substation – UP2020 Lite	<b>GSTR002</b> Rev. 02 03/10/2019

Each test must be performed by applying a specific voltage value (corresponding to the level specified for each circuit) to each couple of circuits that are listed below, whereas the remaining circuit is grounded

- a) AC power supply input (level 4);
- b) Signaling output and 24 V<sub>DC</sub> power supply output (level 3);

The voltage level must be equal to the prescribed value for each circuit.

The prescribed tests are listed below and they all have to be executed according to the methods and values defined in the corresponding reference standard EN 60255-5:

Impulse withstand test	Overvoltage category 4	AC power supply inputs,	PSBC
Impulse withstand test	Overvoltage category 3	Inputs, outputs and 24V <sub>DC</sub> input	PSBC\UE
Dielectric strength test	AC test voltage 2 kV	AC power supply input	PSBC
Measurement of the Insulation resistance	≥100 MΩ to 500 V <sub>DC</sub>	AC Power supply	PSBC
Measurement of the Insulation resistance	≥10 MΩ to 500 V <sub>DC</sub>	Inputs, outputs, DC Power supply	PSBC\UE

**Table 8 - Insulation Tests in compliance with EN 60255-5**

### 8.2.3 Check of all of the functionalities

The regular performance of all of the prescribed functions must be verified, as well as the correct issue of the related signals, in correspondence to the prescribed intervention/nonintervention limits.

#### 8.2.3.1. UE

All the functional characteristics described in the previous chapters of this document and in the other GSTR001 technical documents must be checked.

In particular, it is important to verify:

- the integration of the RTU with the Central System for each specific IEC 60870-5 profile described in the GSTR001/1/A3 specification.
- The automations described in the confidential documents

All these tests must be performed in Enel laboratories located in Milan, in Bari, in Barcelona (or in any other place indicated by Enel), at the expense of the supplier.

The supplier will organize the test plan as well as a detailed list of all of the tests, which must be approved by Enel.

This is mandatory, to proceed to a systematic and comprehensive check of the functionalities implemented.

#### 8.2.3.2. PSBC

The tests on the PSBC must be executed at the rated voltage and without any loads or batteries connected.

The rectifier performance has to be checked also in the case of voltage interruptions (the first for a duration of 0.3 s, and the second for 180s): in this case the rectifier must return to its normal operating mode, without over voltages exceeding the prescribed threshold.

	GLOBAL STANDARD	Page 37 of 63
	Remote Terminal Unit for MV/LV substation – UP2020 Lite	<b>GSTR002</b> Rev. 02 03/10/2019

In particular, it must be verified that the maximum value of the current supplied, and its alternate component percentage, do not exceed the prescribed threshold, using a dummy load.

The functionality of the circuit controlling the maximum voltage of the rectifier (and the circuits supplying the rectifier itself) must be tested by connecting a proper battery to the power supply.

All of the functions, for which a software control is prescribed, must be also verified. For example, this is the case of the functions related to the regulation and testing of the output voltage, the regulation and testing of the battery threshold test, the exclusion/enabling of the battery test, etc.

#### 8.2.4 Stability check (PSBC only)

The check of the stabilization limits must be carried out on the basis of the information reported in the table below:

Steady state stability (for simultaneous variations of the grid voltage from 90% to 120% of the rated value, under any loading condition from 0% to 100%):	±1%
Dynamic state stability (for load steps that are equal to ±25% of half of the PSBC rated current):	±5%

**Table 9 - Stability check**

#### 8.2.5 Electromagnetic compatibility tests

The aim of these tests is to verify the correct operation of either the PSBC or the UE, which are subjected to the application of various electromagnetic phenomena.

The Power supply and the UE must be in compliance with :

- **CISPR 32** Electromagnetic compatibility of multimedia equipment - Emission requirements
- **CISPR 11** Industrial, scientific, and medical (ISM) equipment - Radio frequency disturbance characteristics - Limits and methods of measurement

Immunity limit tests must follow hereinafter, and be compliant with the following:

	GLOBAL STANDARD		Page 38 of 63
	Remote Terminal Unit for MV/LV substation – UP2020 Lite		<b>GSTR002</b> Rev. 02 03/10/2019

Ring Wave	level 2	IEC 61000-4-12	Local ports
Ring Wave	level 3	IEC 61000-4-12	Field ports
Damped oscillatory waves	level 2	IEC 61000-4-18	Field ports, Local ports, AC & DC Power supply
Fast transient/burst	level 3	IEC 61000-4-4	Local ports, Ground, AC&DC input and Output
Fast transient/burst	level 4		Field ports
Surge 1,2-50/8-20	level 3	IEC 61000-4-5	AC&DC input and Output
Power frequency magnetic field	level 3	IEC 61000-4-8	DC input and Output
Power frequency magnetic field	level 3	IEC 61000-4-8	Local ports
Power frequency magnetic field	level 4	IEC 61000-4-8	Field ports
Radiated, radio-frequency, electromagnetic field	level 3	IEC 61000-4-3	Field and local ports, Ground, AC&DC inputs and outputs
Radiated, radio-frequency, electromagnetic field (digital radio telephones)	level 3	IEC 61000-4-3	
Test voltage level at main frequency	level 3	IEC 61000-4-16	Field and local ports, Ground, AC&DC inputs and outputs
Conducted common mode disturbances in the frequency range 0 Hz to 150 kHz			
Conducted disturbances induced by radio-frequency fields	level 3	IEC 61000-4-6	Field and local ports, Ground, AC&DC inputs and outputs

**Table 10 - EMC Reference Standards**

**All the EMC tests must be performed, as indicated in the table above, in laboratories which are accredited according to the current standards.**

#### 8.2.5.1. UE

With reference to the above mentioned Standards, the tests to be performed onto the UE refer to the port classification listed below:

- USB port, RJ45, RS232 to DCE, power port must be intended as local ports;
- RC output ports, RS and TM ports, field power port must be intended as field ports.

#### 8.2.5.2. PSBC

With reference to the above mentioned Standards, the tests to be performed onto the PSBC refer to the port classification listed below:

- the 24 V<sub>DC</sub> output port, the USB port must be intended as local ports;
- the 230/100 V<sub>AC</sub> input port must be intended as field ports.

#### 8.2.6 Thermal behavior test (PSBC only)

The power supply thermal map must be measured at the prescribed maximum values of the input/output parameters; the test must be executed under standard climatic conditions, as reported below:

- Temperature: 15 ÷ 35 °C;
- Atmospheric pressure: 86 ÷ 106kPa;
- Relative humidity: 45 ÷ 75 %

	GLOBAL STANDARD	Page 39 of 63
	Remote Terminal Unit for MV/LV substation – UP2020 Lite	<b>GSTR002</b> Rev. 02 03/10/2019

The over temperature values, measured close to the each component, must be used to verify that, at the maximum prescribed operating temperature, the maximum permissible temperature is not exceeded for that component.

The thermal map must also be used to define the time thermal constant, which must be used in the temperature variation test, described in the next paragraph.

### 8.2.7 Climatic Tests

The description of the tests on the RTU as well as the methodology of their execution are described in the standards recalled in the following table (Table 11 - Climatic Tests).

Two different tests must be executed, respectively with the PSBC switched OFF and ON.

During the tests, the clock stability must be verified.

Switched off and rated powered equipment	Dry heat	+85 °C ± 2 °C (16 hours)	IEC 60068-2-2:2007	Environmental testing - Part 2-2: Tests - Test B: Dry heat
	Damp heat	+40 °C ± 2 °C, RH = 93% ± 3% (4 days)	IEC 60068-2-78:2012	Environmental testing - Part 2-78: Tests - Test Cab: Damp heat, steady state
	Cold	(-10 ± 3)°C (16 hours)	IEC 60068-2-1:2007	Environmental testing - Part 2-1: Tests - Test A: Cold
	Change of temperature	TA = -25°C; TB =85°C; (3 hours+3 hours)	IEC 60068-2-14:2009	Environmental testing - Part 2-14: Tests - Test N: Change of temperature

**Table 11 - Climatic Tests**

At the beginning and the end of each test, as well as every 4h, during the execution of a single test, two issues of supply at the maximum current (with a duration of 30s each) must be caused.

During the N test, the above mentioned issues must be caused at the end of each evolution of the temperature from the minimum to the maximum value, and vice versa.

The maximum interval between two consecutive tests shall not exceed 3 days, except for the humid heat and cold tests, for which the maximum interval shall not exceed 2 hours, including the stabilization process.

In order to verify the correct operation of the power supply after the execution of all of the prescribed type tests, the following tests must be repeated:

- 1) Visual inspection;
- 2) Tests of insulation and dielectric strength;
- 3) Check of all of the functionalities;

### 8.2.8 Mechanical tests

The tests to be executed on the RTU, as well as the related methodology of the execution, are described within the standards recalled in the following table:

	GLOBAL STANDARD	Page 40 of 63
	Remote Terminal Unit for MV/LV substation – UP2020 Lite	<b>GSTR002</b> Rev. 02 03/10/2019

TEST	DESCRIPTION	REMARKS										
STATIONARY VIBRATION (SINUSOIDAL)	<ul style="list-style-type: none"> <li>Displacement amplitude (mm) : 0,75;</li> <li>Acceleration amplitude (m/s<sup>2</sup>) : 10;</li> <li>Frequency range (Hz): 10-500 Duration: 5 cycles per axis.</li> <li>Fixing points: those of the standard mounting structure, considering the UP full equipped without batteries.</li> <li>Acceptance criteria: Correct operation of the device during the test (e.g. execution of open/close commands on a switch)</li> </ul>	Reference standard: EN 60068-2-6 (method Fc)										
STATIONARY VIBRATION (RANDOM)	<ul style="list-style-type: none"> <li>Spectrum A.1 "Transportation" – Tab.A2 – Category 2 (EN 60068-2-64)</li> <li>Duration: 0.5 hours per axis (3 axis)</li> <li>Fixing points: as in standard shipping position without package.</li> <li>Acceptance criteria: No damage of the device</li> </ul>	Reference Standard: EN 60068-2-64 (method Fh) Category: 2 (transportation-water, trailers, lorries, in areas with well developed road systems)										
SHOCK	<ul style="list-style-type: none"> <li>3 positive impulses and 3 negative impulses for each axis, equal to 15g for 11 ms</li> <li>Acceptance criteria: <ul style="list-style-type: none"> <li>No damage of the device</li> <li>Correct operation of the device after the test</li> </ul> </li> </ul>	Reference Standard : IEC 60068-2-27 Test Ea and guidance: Shock  IEC 60721-4-2, table 6 class 2M2 of the standard.										
FREE FALL	<ul style="list-style-type: none"> <li>Test to be performed on the same specimen that passed the SHOCK test</li> <li>Applied to the [product + packaging]</li> <li>2 free falls on a concrete floor</li> <li>height of the fall along the axis perpendicular to the pallet (Z axis) varies in function of the total mass under test:</li> </ul> <table border="1" style="margin-left: 40px;"> <thead> <tr> <th>Total mass exceeding [Kg]:</th> <th>Height of the fall [cm]:</th> </tr> </thead> <tbody> <tr> <td>&gt;30</td> <td>50</td> </tr> <tr> <td>&gt;40</td> <td>40</td> </tr> <tr> <td>&gt;50</td> <td>30</td> </tr> <tr> <td>&gt;100</td> <td>20</td> </tr> </tbody> </table> <ul style="list-style-type: none"> <li>Acceptance criteria<sup>3</sup>: <ul style="list-style-type: none"> <li>No damage of the device</li> <li>Correct operation of the device after the test</li> </ul> </li> </ul>	Total mass exceeding [Kg]:	Height of the fall [cm]:	>30	50	>40	40	>50	30	>100	20	Reference Standard :  IEC 60068-2-32 Test Ed: Free Fall (procedure 1)  IEC 60721-4-2, table 6 class 2M2 of the standard.
Total mass exceeding [Kg]:	Height of the fall [cm]:											
>30	50											
>40	40											
>50	30											
>100	20											

**Table 12 - Mechanical test**

### 8.3 Acceptance tests

The acceptance tests are those indicated in Par. 8.1 clause 1, 2 and 3, and here reported:

1. Visual examination
2. Isolation and dielectric strength tests



	GLOBAL STANDARD	Page 41 of 63
	Remote Terminal Unit for MV/LV substation – UP2020 Lite	<b>GSTR002</b> Rev. 02 03/10/2019

### 3. Checking of all the functions

The acceptance tests must be carried out using a specifically designed and automated test equipment (ATS also named SCA). Each device must be accompanied by a report stating that all ATS tests have been concluded successfully. Test 2 can be performed not directly by the ATS equipment, but the operator must input a confirmation that the specimen under test has passed the test in the opportune technological station. ATS could be certified from a third party laboratory, or is part of the Technical Conformity Assessment, as described in the GSTX001 Global Standard.

#### 8.3.1 Preliminary checks

- Check of the RTU 24V DC supply voltage:
- Tolerance check, with powered base unit.

Check of the motors 24V DC supply voltage:

- Tolerance check with maximum load.

Upload of the testing configuration:

The testing configuration must be performed in order to verify all of the available input and output

Check of correct RTU initialization:

- Link which opens on the visualization channel, with request and check of the internal diagnostic status.

Check of the PC connection functionality:

- A check of the PC connection functionality to the UE and PSBC ports.

#### 8.3.2 Functional check

Serial port check:

- The basic electrical functionality of the port must be verified.

Remote signal check:

- Electrical functionality check in open/close conditions.

Remote control check:

- Check of the electrical functionality of closing remote controls and relative execution time (the latter to be done only on the first remote control).

Telemetry check:

- Parametric check of the single remote measurements to the following values: -6mA, 4mA, 0mA, 6mA, 20mA.

---

<sup>3</sup> An annex document will be provided for a detailed description of the acceptance methods for SHOCK and FREE FALL tests.

	GLOBAL STANDARD	Page 42 of 63
	Remote Terminal Unit for MV/LV substation – UP2020 Lite	<b>GSTR002</b> Rev. 02 03/10/2019

### 8.3.3 Automatic Testing System (ATS)

The ATS is used to perform the acceptance tests on the individual product parts of a UP2020 Lite (PSBC and UE2020 L8 or L16).

The ATS (formerly SCA) is an integral part of UP2020 Lite project therefore it is subjected to the Technical Conformity Assessment process, as described in GSTX001, which replaces the old specification SQP0101\_Certificazione SCA-ed 2.

In particular, the minimum<sup>4</sup> tests that the apparatus under test must pass on the ATS are the following:

#### PSBC:

- Visual Inspection
- Confirmation for passing insulation and dielectric strenght tests
- Correct operation with all the nominal input Voltages and frequencr requested (230 Vac and 100 Vac, 50Hz and 60Hz)
- Confirmation of the firmware version
- Polarity check
- Optical signalization (LEDs)
- Push Buttons functionality check
- Check for the battery temperature functionality
- Functional indication of the LED: VAC IN
- Functional indication of the LED: VCC LOW
- Functional indication of the LED: VCC OUT
- Functional indication of the LED: VCC MAX and rectifier failure
- Functional indication of the LED: BATT FAIL
- Check for the Battery efficiency test functionality
- Check for 42-1 sectionalizer functionality
- Check for 42-M sectionalizer functionality and auxiliary contact signalization
- Check of VAC reading over a -10% , +20% Vn range
- 12 VDC ouput
- Check of Voltage and current at maximum load
- Current limitation function in overlad condition (limit to 5A)
- Short Circuit Self Protection AC side
- Short Circuit Self Protection DC side

#### UE2020 L8 and L16:

- Visual Inspection
- Confirmation for passing insulation and dielectric strenght tests
- Check of the correct functionality of all the communication ports onboard: serial and RJ45.
- 43 L/T Selector functionality
- Optical signalization (LEDs)

---

<sup>4</sup> The provider can include further tests in the ATS in name of quality reasons. ENEL may decide to include some of these further tests in an updated version of the product technical specification as basic functional tests.

	GLOBAL STANDARD	Page 43 of 63
	Remote Terminal Unit for MV/LV substation – UP2020 Lite	<b>GSTR002</b> Rev. 02 03/10/2019

- Test of all the existing IMS connectors
  - Power supply presence
  - Reading OPEN position
  - Reading CLOSE position
  - OPEN command
  - CLOSE Command
- Test of all the existing RG connectors
  - 67 signal
  - 51 signal
  - Digital input signal (RVL)
  - Digital Output
  - Calibration of the analog input channel
- Test of other interfaces
  - PT100 temperature sensor test
  - Door open signal
  - Transformer open signal

	GLOBAL STANDARD	Page 44 of 63
	Remote Terminal Unit for MV/LV substation – UP2020 Lite	<b>GSTR002</b> Rev. 02 03/10/2019

## 9 SUPPLY REQUIREMENTS

### 9.1 Voltage selector switch in the PSBC

In case of pole mounted installations, the input voltage to PSBC can be provided by a transformer having the secondary winding voltage: 230V<sub>AC</sub> or 100V<sub>AC</sub>. The choice between a 100 V and 230 V<sub>AC</sub> power supply must be possible by means of a selector switch, positioned at the rear (see also **Paragraph 6.2** for power supply characteristics). As default position, **the power supply must be provided with the selector switch set to 230 V<sub>AC</sub>.**

### 9.2 TCA documents and Manuals

#### 9.2.1 TCA documents

The Enel technical organization unit in charge of the Technical Conformity Assessment of the UP will supervise the technical documentation and the execution of the functional tests required to receive the “Statement of Conformity”, according to GSCG002 prescriptions.

All the technical documentation required during that process shall be in local language of Enel technical organization unit in charge of the TCA for the RTU or in English. The TCA documents that shall be delivered include:

- **Type A documentation** (Not confidential documents used for product manufacturing and management from which it is possible to verify the product conformity to all technical specification requirements, directly or indirectly).
- **Type B documentation** (Confidential documents used for product manufacturing and management where all product project details are described, in order to uniquely identify the product object of the TCA). This type of documentation must be delivered only to the Enel technical organization unit in charge of the TCA
- **TCA dossier** (Set of final documents delivered by the Supplier for the TCA)  
The supplier shall provide the TCA Dossier on digital support.

#### 9.2.2 Manuals

The supplier shall provide on digital support all the end-user manuals of the UP and its components (e.g. operation, maintenance and installation manual, electric schemes, overall dimensional drawings, plate drawing, product colored pictures, etc).

All the manuals shall be in the local language of the UP destination country.

#### 9.2.3 Safety warnings on Plate

The safety warnings required in the plate of the UP and its components must be written in the local language of the UP destination Country.

## 10 AMBIENT OPERATING CONDITIONS

The apparatus provided must be in compliance with the operating conditions listed below:

- Ambient temperature limit in the range of -25 ÷ 85 °C;
- Atmospheric pressure in the range of 70 ÷ 106 kPa;
- Humidity limit of 93% at the max ambient temperature;
- Storage temperature in the range of -25 ÷ 85 °C.

	GLOBAL STANDARD	Page 45 of 63
	Remote Terminal Unit for MV/LV substation – UP2020 Lite	<b>GSTR002</b> Rev. 02 03/10/2019

## 11 ELECTROMAGNETIC COMPATIBILITY

### 11.1 Immunity requirements

The UE and the PSBC panels must be compliant with the current standards on EMC.

### 11.2 Emission limits

The Power supply must be in compliance with the current regulations on electromagnetic noise emission limits, and in particular the UE must be in compliance with:

- **CISPR 32:2008: Information technology equipment - Radio disturbance characteristics - Limits and methods of measurement (international standard);**

## 12 SAFETY REQUIREMENTS

Each component of the RTU, including the non-electrical ones, must be in compliance with all of the current safety regulations (where applicable).

## 13 SOFTWARE

### 13.1 Remote connection with the Center

The supplier must interface with the Center via the software package, made available by ENEL.

The procedures of data exchange, related to each required activity, must fully operate automatically and without operator intervention.

Arrangements (in the processes of exchange and/or coding of data) must be adopted, which can provide a level of data integrity equivalent to I<sub>3</sub> (CEI-EN 60870-5-1) for the execution of remote controls.

Each activity must include the opening and closing procedure of the Communication Session; this procedure must be performed automatically also, without any operator involvement, and it must be performed also to prevent unwanted access to the system, by using a security procedure based on the exchange of dynamic passwords, which will be provided especially by ENEL.

### 13.2 Remote programming and configuration

A suitable software module must be provided to perform remote configuration / upgrade for one or more UEs (management of lists of devices) is also required, by means of both the Center and the modem normally used for remote control or of a standard PC with a modem.

The software must take into account the features necessary in case of communications channels that can be slow, with high packet error rate and high delays (packets error rate up to 10% and delay of the packets higher than 3 seconds).

It is necessary a remote programming tool / full management tool based on a secure web server on RTU.

### 13.3 Local programming and configuration

The local operations of diagnostics, programming and configuration of the UE will be carried out through a USB 2.0 port, positioned in front.

For this purpose, an appropriate program "RTU Configurator" (see Annex 1) must be provided, which is suitable to be run on a laptop PC equipped with Windows 7 or Windows 10 64 bit, allowing communication with the UE, via the local port of configuration (USB).

*Monitoring input/output signals and automatisms*

A "RTU Viewer" program must be available through the configuration/programming laptop, which allows the activation of the following functions at least:

	GLOBAL STANDARD	Page 46 of 63
	Remote Terminal Unit for MV/LV substation – UP2020 Lite	<b>GSTR002</b> Rev. 02 03/10/2019

- status monitoring of the digital inputs;
- status monitoring of the analog inputs;
- status monitoring of the control outputs (relay);
- status monitoring of the digital outputs;
- on-line monitoring of the transitions between states of the automatism for each switchgear (with visualization and recording of the transition sequence);
- control launch for the opening/closing of the IMS/switches and the switching-off of the automation systems;
- local downloading of the Events-and-Measures Buffer;
- monitoring of the operating status of the link (Initialization in progress, waiting for a connection, connected)

The user interface must be represented by a screen which includes the following information at least:

1. the status of the various signals (opening/closing of each switchgear, intervention of the associated RGDM or RGDAT, feeder and busbar voltage Presence/Absence, etc..)
2. online values of the measurements;
3. the possibility of sending commands:
  - opening/closing of a switchgear;
  - switching-off of the automation systems corresponding to the selected IMS;
  - downloading Events Buffer;
  - downloading Measurements Buffer.
4. Significant information related to automation:
  - switched on/off automation systems;
  - temporary inhibition of Automatic Opening;
  - Second reclosing from UP;
  - Inhibited automation system.

Switchgear opening and closing commands sent from the screen must be treated, for automatism and controls, as remote controls from the Center (when the substation is locally operated, it must not be possible to control any switchgear movement from the screen).

The implementation of commands (open/close of switchgear; automatism switch-off; Download buffer) sent from the screen must cause the emission of a spontaneous call which cannot be disabled.

The download of the events from the local file system and/or measurements buffer must not clear its content, which, nonetheless, will be sent back to the Center in the event of a subsequent positive connection.

During the download process of the Buffer, the related virtual controlled on the screen must blink, in order to enable the user to check the progress of the operation.

For on-line monitoring of the transitions between automatism states, for each IMS, (with visualization and possibility of recording the sequence of transitions) a proper man/machine interface must be agreed upon with ENEL.

	GLOBAL STANDARD	Page 47 of 63
	Remote Terminal Unit for MV/LV substation – UP2020 Lite	<b>GSTR002</b> Rev. 02 03/10/2019

## 14 GENERAL PRESCRIPTIONS

### 14.1 Reliability

#### 14.1.1 Normative references

The following terminology is defined in the standard IEC 50. IEC standards published by TC56 prescribe, in a detailed manner, methodologies to be applied in order to define, standardize and verify the reliability requisites of the various equipment, as well as of the items/systems in their entirety.

#### 14.1.2 Formulation of the reliability requirements

In the remainder, the "useful life" of the device is the time that elapses between the end of the period of "early failures" and the beginning of the "faults for aging" one. The duration of the useful life coincides, therefore, with the "period of constant failure rate."

The period of early failures is intended to be zero, or terminated at the time of delivery. This is because the Supplier must implement and provide documentary evidence of all of the possible measurements which are useful to eliminate child mortality.

- The supplier must therefore certify that the equipment was already in the constant failure rate period since the time of delivery.
- The failure rate must be declared by the Supplier, according to the data of the project (by the calculation shown in the documentation) and must not exceed 3.5% per annum for the power supply/battery charger, and 2.5% per annum for the UE, having operated within the prescribed climatic and environmental conditions.
- The minimum period of constant failure rate, i.e. of the useful life, must be at least 10 years.
- For the purposes of the analysis of failure data, it is intended that any restoration (i.e. repair or maintenance) does not change the failure rate during the useful life.

For the reliability analysis during the useful life, the failures which are not attributable to improper use, or incorrect operation, are deemed to be "relevant failures"; in this regard, the Supplier must define, in detail, the scope of use and the eligible maneuvers for the product.

#### 14.1.3 Verification tests of compliance with the declared failure rates

ENEL will agree to the modalities of analysis and verification of all of the data needed to monitor the reliability required throughout the period of useful life.

In this regard, the modalities of logging, classifying (relevant or irrelevant failures), and certifying the maintenance and repair interventions performed by the Supplier will be defined,

In accordance with ENEL, the Supplier must put a computerized archive in place and provide quarterly data on the failure rate, which is measured on the supplied equipment.

ENEL is equipped with an archive where the records (preventive or following a failure) of maintenance interventions are held, in order to perform control checks.

### 14.2 Electronic Boards and components prescriptions

1. **PCB, T<sub>g</sub> ≥ 150° is required.** (glass transition temperature) This requirement is to prevent delamination and crack defects in barrels and PTH solderings.
2. **Industrial temperature range components [-40°C ÷ +85°C]**
3. **Lead Free solder alloys** for both SMD and PTH (to prevent contamination problems)
4. **No 0201 components allowed.**

	GLOBAL STANDARD	Page 48 of 63
	Remote Terminal Unit for MV/LV substation – UP2020 Lite	<b>GSTR002</b> Rev. 02 03/10/2019

#### 14.3 Project technical documentation

Before the installation of the equipment, the supplier must prepare a project documentation to be submitted to ENEL for approval. This project documentation must list in detail all of the solutions adopted by the supplier in order to ensure the required functionality and reliability.

#### 14.4 Spare parts

The spare parts will be defined in the request for proposal. All of the spare parts of the supplied equipment (including firmware and software) must be available for at least 10 years after the expiration of the warranty period.

#### 14.5 Equipment documentation

The provider must produce detailed documentation of the operation, configuration and maintenance of the equipment, accompanied by either the wiring and topographic diagrams, or the lists of components. These documentation must be provided electronically.



	GLOBAL STANDARD	Page 49 of 63
	Remote Terminal Unit for MV/LV substation – UP2020 Lite	<b>GSTR002</b> Rev. 02 03/10/2019

## 15 OPTIONAL SENSOR: NETTUNO

During the tender process, an optional flooding sensor, named NETTUNO will be defined if it takes part of the supply or not.

Nettuno is a flood sensor that could be installed in secondary substation and connected to UP2020 Lite or any other UP generation, in order to prevent costly water damage. The device has a Normally closed (NC) contact. In case of flooding or device failure, the contact will open.

The device must be designed to favor a minimization of the overall dimensions.

### 15.1 Power supply

The device can be powered using 24V DC power supply, with positive pole connected to the ground (Terminal 1 and 9 as Figure 3), exploiting one of the RG connectors of the UP. In case of power failure and subsequent re-feeding, the device must go to operating status in less than 5 seconds.

### 15.2 Operating

The device is able to detect a flood by measuring the resistance at the ends of two terminals available externally on the body of the sensor (F - in the principle diagram of Figure 3).

When an anomaly is detected (water between two terminals), the normally closed contact must open if the anomaly persists for 60 seconds (this signal is collected by Terminal 3).

If the anomaly falls for at least 20 s, the NC contact K must return in retracted position.

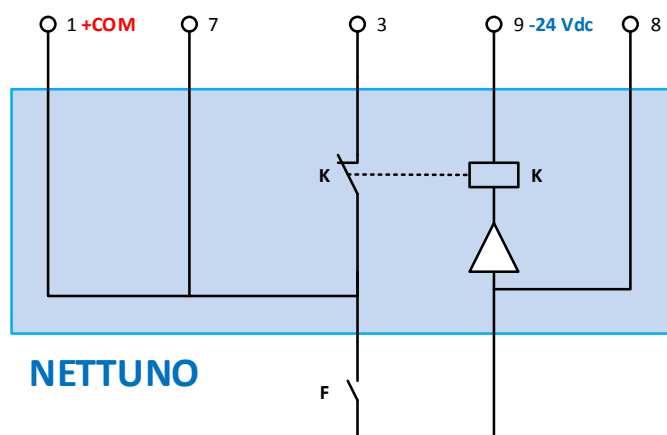



Figure 3 – Principle diagram

In case of device failure the NC contact must open.

	GLOBAL STANDARD	Page 50 of 63
	Remote Terminal Unit for MV/LV substation – UP2020 Lite	<b>GSTR002</b> Rev. 02 03/10/2019

Remote test must be possible using terminal 8 (Figure 3), supplied by common voltage (terminal 7 - Figure 3). Terminal 7 is internally connected with terminal 1 (common voltage). A successful test has as result the opening of the NC contact K.

The device must work correctly if the remote test is not used.

### 15.3 Connection

The external interface is guarantee by a multipolar cable FR2OR2 NPI with 5 wires, section per conductor 0,5 mm<sup>2</sup>, ending with a connector type RG9 pin. Cable length must be not less than 3 m.

The order of connection is defined as follow:

PIN	Functionality UP side
1	Positive Voltage 24VDC / Common Digital input
2	Free
3	Digital input
4	Free
5	Free
6	Free
7	Common Digital Output
8	Digital Output
9	Negative Voltage 24VDC

Table 13 - Wiring

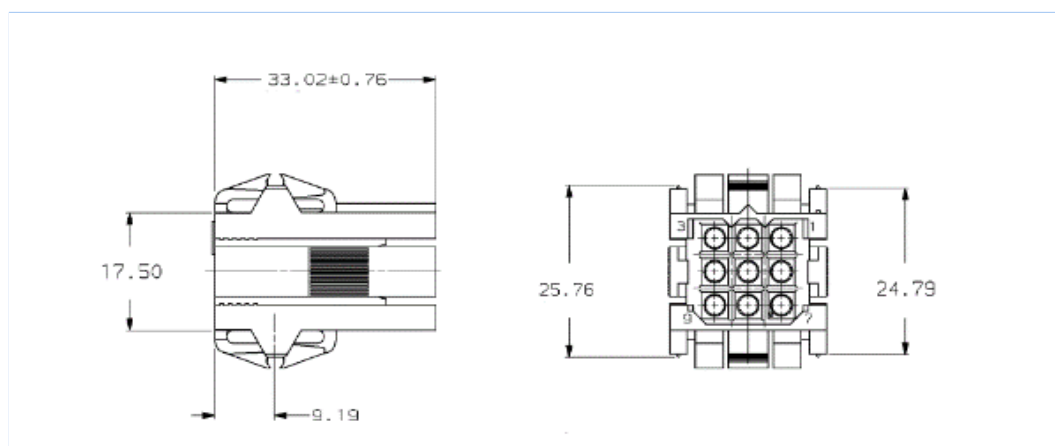



Figure 4 - Connector RG9

### 15.4 Features

The device must have at least the following characteristics

- Power supply: 24 VDC nominal,  $\pm 20\%$
- Absorption:  $< 0,7$  W;

	GLOBAL STANDARD	Page 51 of 63
	Remote Terminal Unit for MV/LV substation – UP2020 Lite	<b>GSTR002</b> Rev. 02 03/10/2019

- Relay contact capacity: potential-free contact (24VDC), 1 A on-load;
- Protection degree: IP67 CEI EN 60529;
- Safety requirements: CEI EN 61010-1, CEI EN 61010-2-032; CAT II;
- EMC: CEI EN61000-6-3, EN 50130-4;
- Max dimensions: 160 x 50x 50 mm (LxHxP);
- Case plastic material UL94 VO, CTI ≥500;
- Environmental conditions eligible operation: Temperature -15°C ÷ 70°C, humidity 0 ÷ 100%;
- Resistant to environmental influences (dust, fibers, insects, humidity, temperature).

#### 15.5 Installation

The device must be supplied with a wall fixing system with adjustable height from the ground. The fixing must not require any disassembly or opening of the case.

#### 15.6 Reliability

The device must have at least the following characteristics:

- Fault rate < 0,4% for year;
- Lifetime 10 years.

#### 15.7 Manual and accompanying documentation

The supplier shall provide on digital support all the end-user manuals of the device (e.g. operation, maintenance and installation manual, electric schemes, overall dimensional drawings, plate drawing, product colored pictures, etc).

All the manuals shall be in the local language of the destination country.

Moreover, the device must have the following accompanying documentation:

- Test certificate.

#### 15.8 Plate Data

The device must have the following plate data:

- CE marking compliant with directive 1999/05 / EC;
- Device serial number.

	GLOBAL STANDARD	Page 52 of 63
	Remote Terminal Unit for MV/LV substation – UP2020 Lite	<b>GSTR002</b> Rev. 02 03/10/2019

## 16 APPENDIX

ID_IN	PIN	Connector	Description	UE2020 L8	UE2020 L16
0	-	L/R selector	Local operating mode	1	1
1	-	L/R selector	Remote operating mode	1	1
2	-	input terminal Door Op	substation door opening	1	1
3	-	input terminal TR SD	transformer switch opening	1	1
4	7	PSBC/UE connector	Motor failure	1	1
5	8	PSBC/UE connector	MAINS failure/BVI	1	1
6	9	PSBC/UE connector	rectifier failure	1	1
7	10	PSBC/UE connector	Low V <sub>DC</sub>	1	1
8	11	PSBC/UE connector	Battery Failure	1	1
9	5/4	i <sup>th</sup> SG connector	switch disconnecter closed	8	16
10	5/9	i <sup>th</sup> SG connector	switch disconnecter open	8	16
11	1/2	i <sup>th</sup> FPI connector	Overcurrent detection (FPI <sub>ov</sub> )	8	16
12	1/5	i <sup>th</sup> FPI connector	Zero sequence current detection (FPI <sub>0</sub> )	8	16
13	1/3	i <sup>th</sup> FPI connector	remote signal	8	16
	-	remote signal input terminal			
Total				49	89

**Table 14 – Remote Signals**

ID_OUT	PIN	Connector	Description	UE2020 L8	UE2020 L16
0	12/8	i <sup>th</sup> SG Connector	Remote Closing Control	8	16
1	12/7	i <sup>th</sup> SG Connector	Remote Opening Control	8	16
2	7/8	i <sup>th</sup> FPI Connector	Digital Output	8	16
Total				24	48

**Table 15 – Remote Controls/Digital outputs**

	GLOBAL STANDARD	Page 53 of 63
	Remote Terminal Unit for MV/LV substation – UP2020 Lite	<b>GSTR002</b> Rev. 02 03/10/2019

ID_MEAS	PIN	Position	Description	UE2020 L8	UE2020 L16
0		T <sub>amb</sub> Input/output terminal	4 wire PT100 terminal for ambient temperature measurement	1	1
1	4/6	i <sup>th</sup> FPI connector	Telemeasuring enabled	8	16
	-	Telemeasuring input terminal			
Total				9	17

**Table 16 – Telemeasurement Signals**

	GLOBAL STANDARD	Page 54 of 63
	Remote Terminal Unit for MV/LV substation – UP2020 Lite	<b>GSTR002</b> Rev. 02 03/10/2019

## AT COMMANDS OF THE DUAL-BAND MODEM GSM900/DCS1800

The following AT commands (in alphabetical order) are included among the features, performance, and requirements of the dual-band GSM900/DCS1800modem:

- +CME            Mobile equipment result codes
- +CMS            Message service failure result codes
- A/                Re-execute last command
- AT&C            Set DCD signal
- AT&D            Data Terminal Ready options
- AT&F            Restore default configuration
- AT&S            Set DSR signal
- AT&T            Autotest
- AT&V            Display current configuration
- AT&W            Save current configuration
- AT+CBST        Bearer type selection
- AT+CEER        Displays why last call was disconnected
- AT+CLCK        Facility lock
- AT+CMGD        Delete messages
- AT+CMGF        Message format
- AT+CMGL        List messages
- AT+CMGR        Read message
- AT+CMGS        Send messages
- AT+CMGW        Write message to memory
- AT+CMSS        Send messages from storage
- AT+CNMI        New message indication to terminal equipment
- AT+COPS        Operator selection
- AT+CRLP        Radio Link Protocol parameters
- AT+CSQ        Display signal strength
- AT+ICF        Character framing
- AT+IFC        Local flow control
- AT+ILRR        Display local port rate
- AT+IPR        Set terminal equipment data rate
- ATA            Manual answer an incoming call
- ATD            Dial a telephone number
- ATDL            Redial last telephone number
- ATE            Echo
- ATH            Hang up
- ATO            Change from command mode to data mode
- ATSO            Auto-answer mode
- ATSS            Set the command termination character

	GLOBAL STANDARD	Page 55 of 63
	Remote Terminal Unit for MV/LV substation – UP2020 Lite	<b>GSTR002</b> Rev. 02 03/10/2019

- ATV            DCE response format
- ATZ            Load user profile.

**DATA EXCHANGE CIRCUITS**

- C.102        Signal Ground or Common Return
- C.103        Transmitted Data
- C.104        Received Data
- C.105        Request to send
- C.106        Ready for sending (Clear to Send)
- C.107        Data set ready
- C.108/2     Data terminal ready
- C.108/1     Connection data set to line
- C.109        Carrier detector
- C.113        Transmitter signal element timing (DTE source) [optional]
- C.114        Transmitter signal element timing (DCE source) [optional]
- C.115        Receiver signal element timing (DCE source) [optional]
- C.125        Ring Indicator.

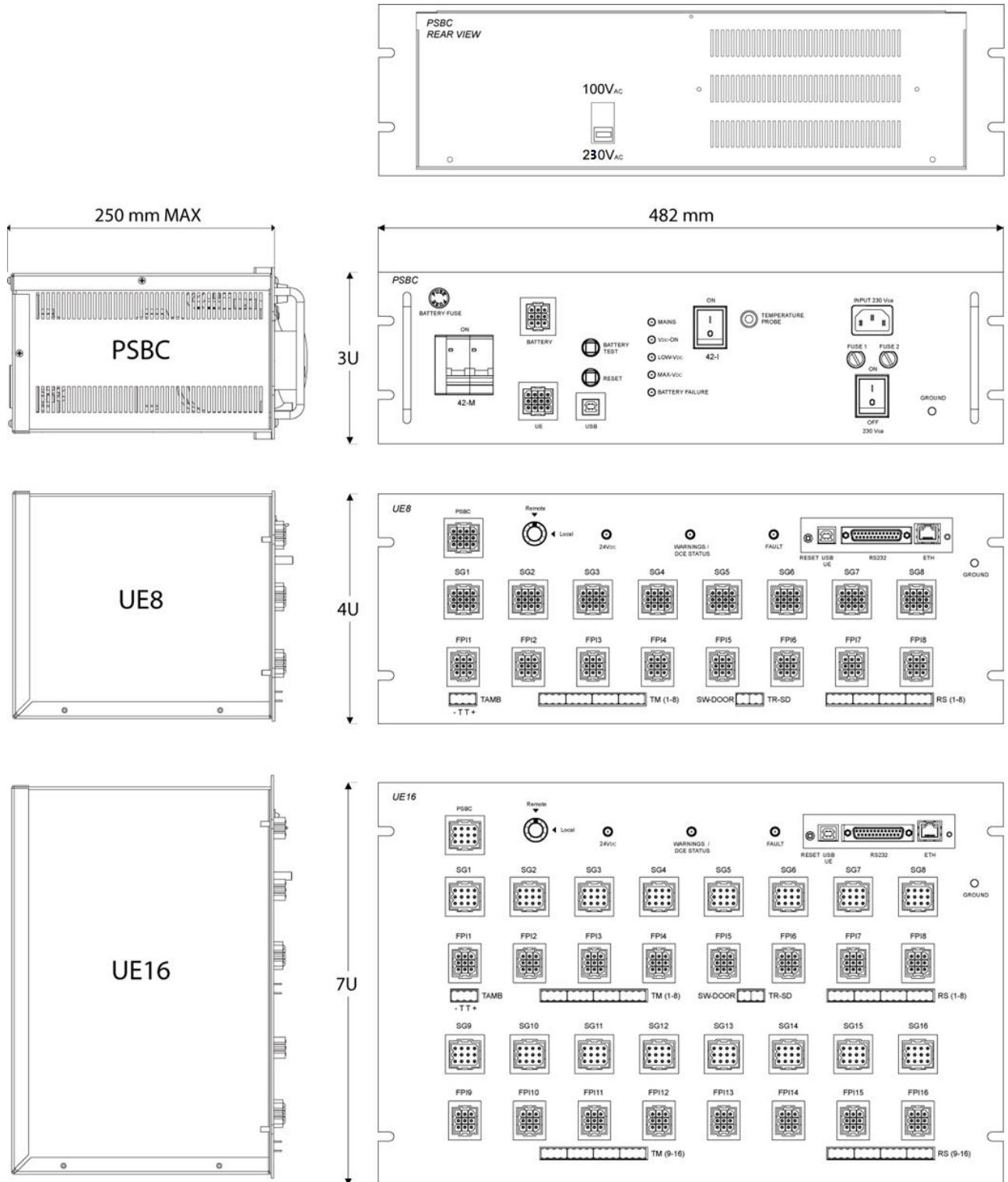



Figure 4 – Views of the chassis of the UE2020 L8 (UE8 in the figure), UE2020 L16 (UE16 in the figure) and PSBC



	GLOBAL STANDARD	Page 57 of 63
	Remote Terminal Unit for MV/LV substation – UP2020 Lite	<b>GSTR002</b> Rev. 02 03/10/2019

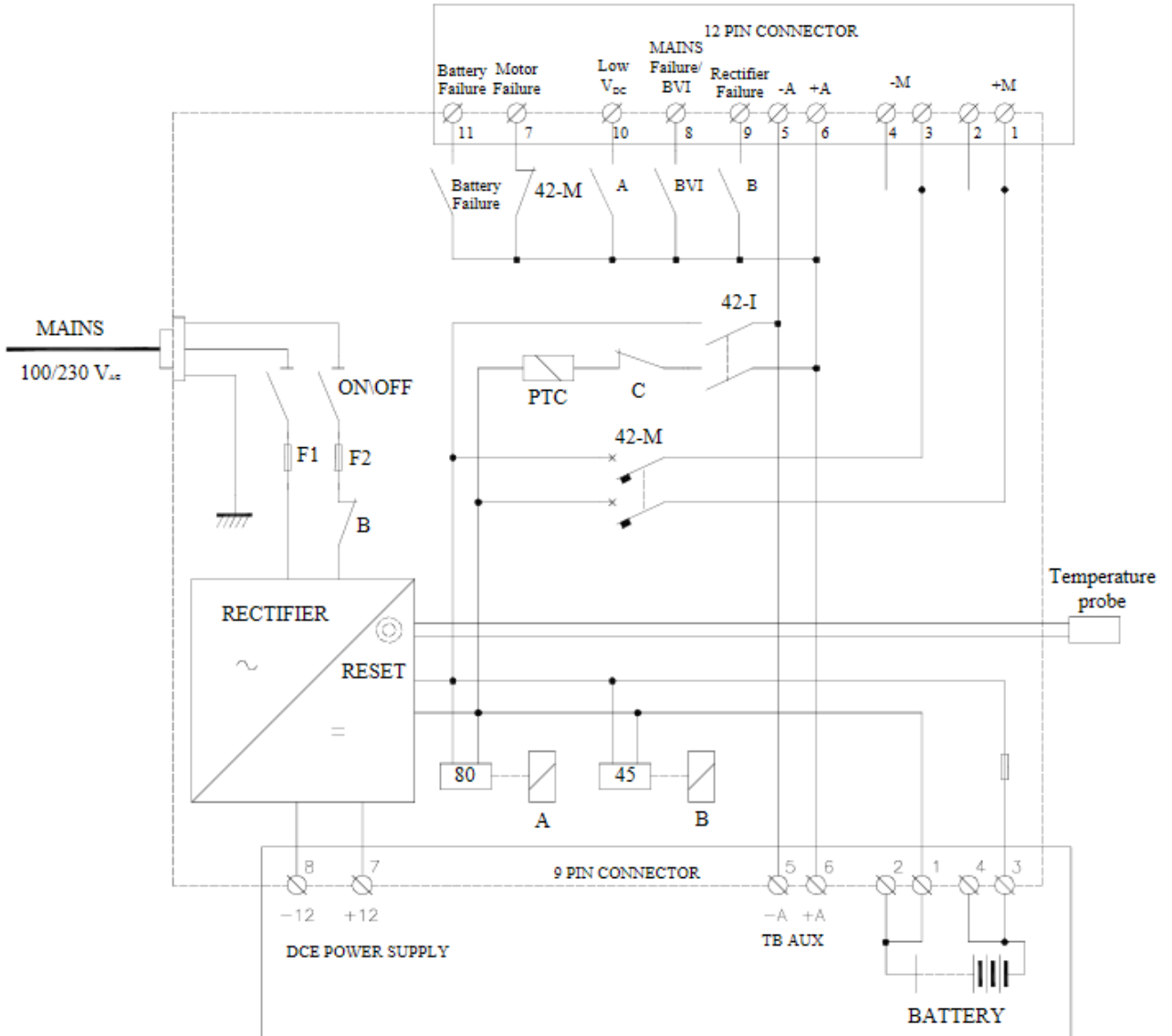

Figure 5 – Circuit diagram of the power supply

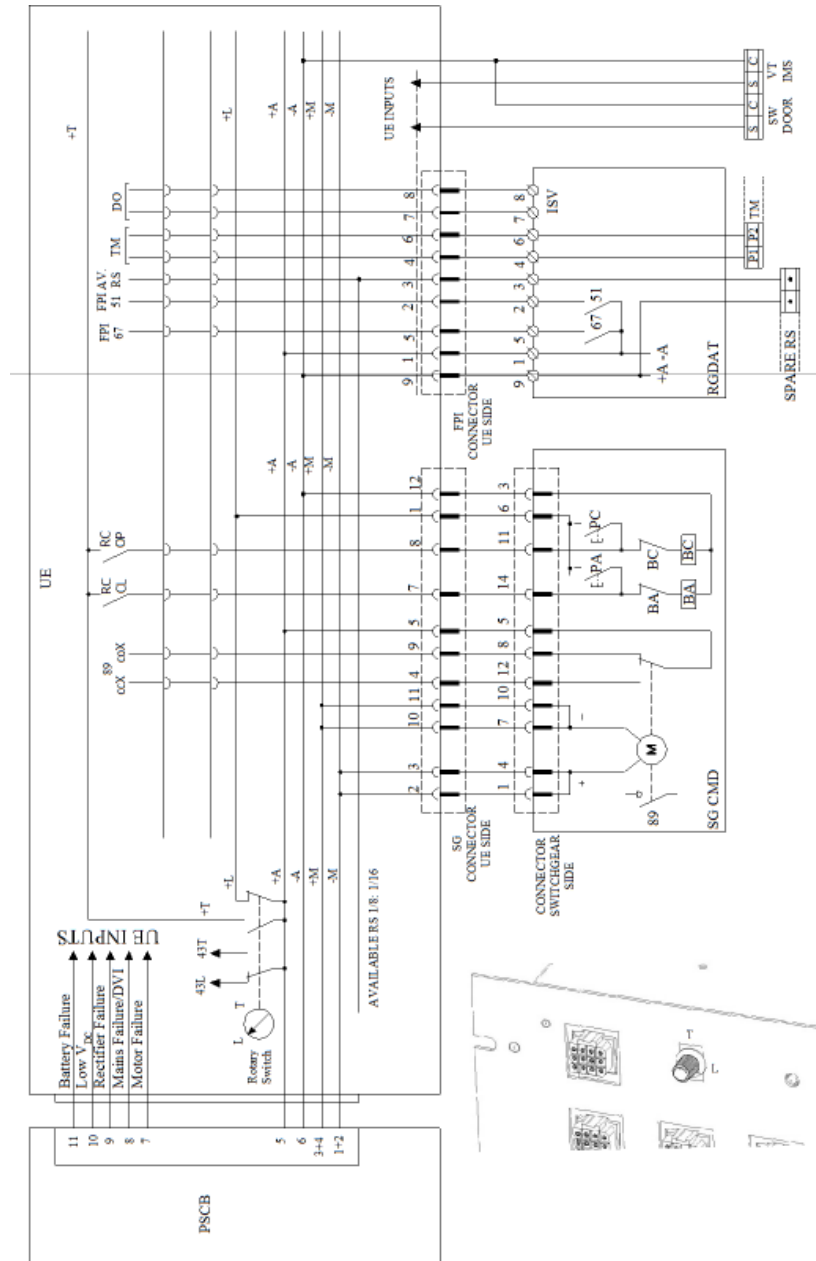

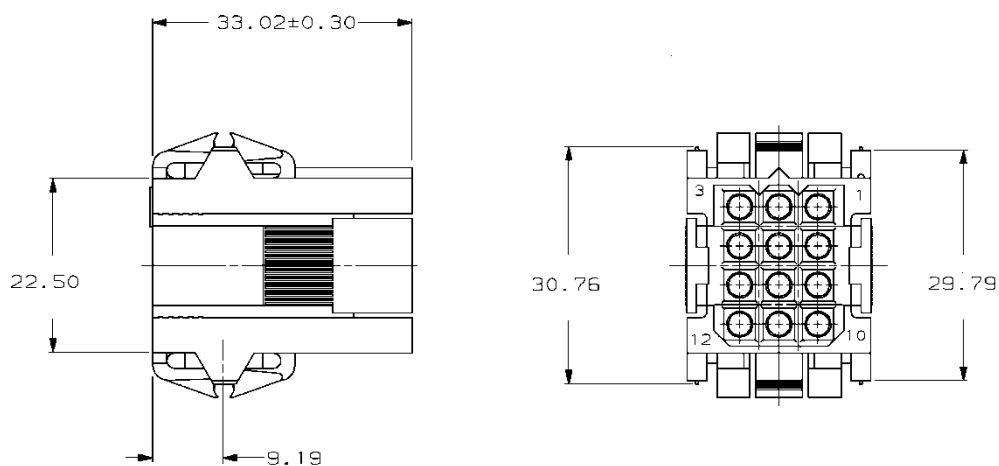

Figure 6 – Circuit diagram of the PSBC/UE field connections and rotary switch detail

	GLOBAL STANDARD	Page 60 of 63
	Remote Terminal Unit for MV/LV substation – UP2020 Lite	<b>GSTR002</b> Rev. 02 03/10/2019

Pin	Name	Description	Pin	Name	Description
1	+L	Local controls power supply (+24 V <sub>DC</sub> )	7	OP	Remote control opening
2	+M	Motor power supply (+24 V <sub>DC</sub> )	8	CL	Remote control closing
3	+M	Motor power supply (+24 V <sub>DC</sub> )	9	89 cax	Remote signal of end position open SG
4	89 ccx	Remote signal of end position closed SG	10	-M	Motor power supply (-24 V <sub>DC</sub> )
5	RS Com	RS Common of the Switchgear	11	-M	Motor power supply (-24 V <sub>DC</sub> )
6		Not in use	12	-A	(-24 V <sub>DC</sub> ) Controls Common

**Table 17 – SG connector pinout (FLOATING PART)**



**Figure 7 – Dimensional characteristics of the female 12 pin connector from switchgear**

Pin	Name	Description
1	RS Com	Power supply (+24 V <sub>DC</sub> ) and Common
2	RS <sub>ov</sub>	Overcurrent operate condition
3	RS	Spare RS
4	TM+	Analog input (pole 1)
5	RS <sub>0</sub>	Zero sequence current operate condition
6	TM-	Analog input (pole 2)
7	DO COM	Digital Output Common
8	DO	Digital Output
9	-	Power supply (-24 V <sub>DC</sub> )

**Table 18 – FPI connector pinout (FLOATING PART)**

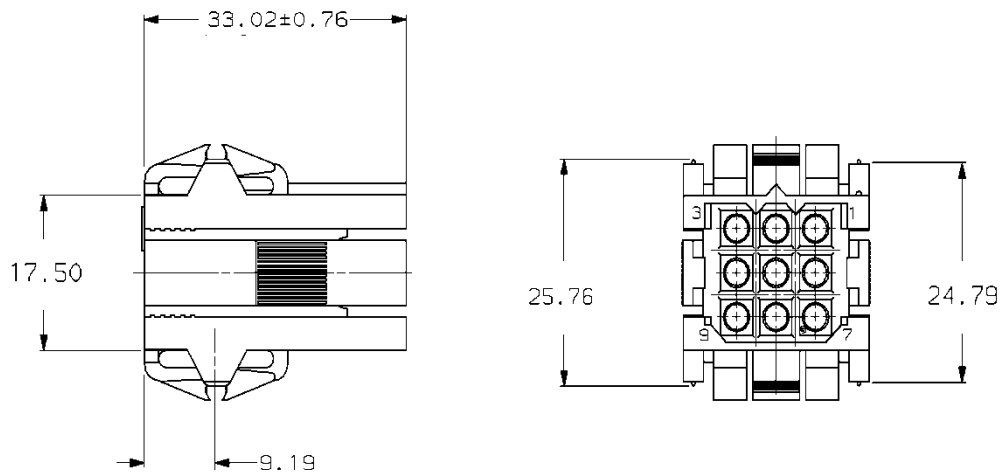
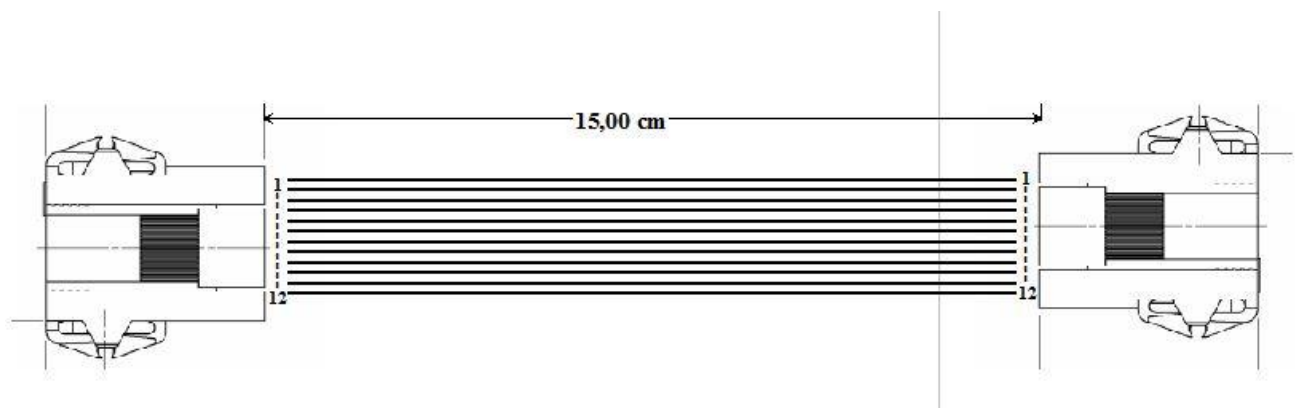

**Figure 8 – Dimensional characteristics of the female 9 socket connector from RGDAT/RGDM**

	GLOBAL STANDARD	Page 62 of 63
	Remote Terminal Unit for MV/LV substation – UP2020 Lite	<b>GSTR002</b> Rev. 02 03/10/2019

Pin	Name	Description	Pin	Name	Description
1	+M	Motor Power supply (+24 V <sub>DC</sub> )	7	Mot Fail	Motor Failure
2	+M	Motor Power supply (+24 V <sub>DC</sub> )	8	Mains fail/BVI	Mains failure/BVI
3	-M	Motor Power supply (-24 V <sub>DC</sub> )	9	Rect Fail	Rectifier Failure
4	-M	Motor Power supply (-24 V <sub>DC</sub> )	10	Low V <sub>DC</sub>	Low V <sub>DC</sub>
5	+A	UE Power supply (+24 V <sub>DC</sub> )	11	Batt Fail	Battery Failure
6	-A	UE Power supply (-24 V <sub>DC</sub> )	12	-	-

**Table 19 – Pinout (floating and fixed part of the 12 pin connector, either power supply side or RTU side)**



**Figure 9 – Connection between PSBC and UE**

	GLOBAL STANDARD	Page 63 of 63
	Remote Terminal Unit for MV/LV substation – UP2020 Lite	<b>GSTR002</b> Rev. 02 03/10/2019

Pin	Name	Description
1	+ Batt	Battery positive terminal(+24 V <sub>DC</sub> )
2	+ Batt	Battery positive terminal(+24 V <sub>DC</sub> )
3	-Batt	Battery negative terminal(-24 V <sub>DC</sub> )
4	-Batt	Battery negative terminal (-24 V <sub>DC</sub> )
5	+A	Auxiliary Power supply
6	-A	Auxiliary Power supply
7	+12 V <sub>DC</sub>	DCE Power supply(+12 V <sub>DC</sub> )
8	-12 V <sub>DC</sub>	DCE Power supply(-12 V <sub>DC</sub> )
9	-	-

**Table 20 – Pinout (floating and fixed part of the 9 pin connector, power supply side)**

## 17 CYBERSECURITY PRESCRIPTIONS

The equipment has to be compliant to the Enel Cyber Security internal guideline about OT ICS: “Cyber Security Guideline no. 12”. The following Annex is a check list extracted by the Security Guideline and the manufacturer must fill in the “Compliance” columns of the check list.



gict-sgl\_12\_v01\_ics ot security guideline (1).pdf



gict-sgl\_12\_ax\_v01\_ics ot security guidel