



**Material specification code: GRI-GRI-MAT-E&C-0038**

Version no. 1 dated 21/04/2023.

**Subject: GSCM003 MV POLE MOUNTED SWITCH-DISCONNECTORS**

**Application Areas**

Perimeter: *Global*

Staff Function: -

Service Function: -

Business Line: *Enel Grids*

**CONTENTS**

<b>1</b>	<b>DOCUMENT AIMS AND APPLICATION AREA</b> .....	<b>2</b>
1.1	<i>RELATED ORGANIZATIONAL DOCUMENTS TO BE IMPLEMENTED AT COUNTRY LEVEL</i> .....	3
<b>2</b>	<b>DOCUMENT VERSION MANAGEMENT</b> .....	<b>3</b>
<b>3</b>	<b>UNITS IN CHARGE OF THE DOCUMENT</b> .....	<b>3</b>
<b>4</b>	<b>REFERENCES</b> .....	<b>4</b>
<b>5</b>	<b>ORGANIZATIONAL PROCESS POSITION IN THE PROCESS TAXONOMY</b> .....	<b>7</b>
<b>6</b>	<b>DEFINITIONS AND ACRONYMS</b> .....	<b>7</b>
<b>7</b>	<b>DESCRIPTION</b> .....	<b>9</b>
7.1	<i>LIST OF COMPONENTS</i> .....	9
7.2	<i>SERVICE CONDITIONS</i> .....	11
7.3	<i>TECHNICAL CHARACTERISTICS</i> .....	12
7.4	<i>GENERAL CHARACTERISTICS OF THE SWITCHGEAR</i> .....	13
7.5	<i>SWITCH-DISCONNECTOR FOR BARE CONDUCTOR LINES</i> .....	21
7.6	<i>SWITCH-DISCONNECTOR FOR CABLE LINES</i> .....	29
7.7	<i>TESTING</i> .....	32
7.8	<i>CONDITIONS OF SUPPLY</i> .....	37
<b>8</b>	<b>ANNEX A. MOTORIZATION CONNECTION</b> .....	<b>39</b>
<b>9</b>	<b>ANNEX B. CHARACTERISTICS OF SWITCHGEAR SUPPORT</b> .....	<b>40</b>
<b>10</b>	<b>ANNEX C. GENERAL DIMENSIONS</b> .....	<b>43</b>

**THE HEAD OF GLOBAL NETWORK COMPONENTS**

**Fabrizio GASBARRI**



**Material specification code: GRI-GRI-MAT-E&C-0038**

Version no. 1 dated 21/04/2023.

**Subject: GSCM003 MV POLE MOUNTED SWITCH-DISCONNECTORS**

**Application Areas**

Perimeter: *Global*

Staff Function: -

Service Function: -

Business Line: *Enel Grids*

## 1 DOCUMENT AIMS AND APPLICATION AREA

The scope of this document is to provide the technical requirements for the design, manufacturing, testing, supply and delivery of SF6-free MV pole mounted switch-disconnectors for use in Medium Voltage distribution networks of the Enel Group Distribution Companies, listed in Table 1.

Country	Distribution Company
Argentina	Edesur
Brazil	Enel Distribuição Rio Enel Distribuição Ceará Enel Distribuição São Paulo
Chile	Enel Distribución Chile
Colombia	Enel Distribución Colombia
Italy	e-distribuzione
Peru	Enel Distribución Perú
Romania	Enel Distributie Banat Enel Distributie Dobrogea Enel Distributie Muntenia
Spain	e-distribución

**Table 1 - Distribution Companies**

This document shall be implemented and applied to the extent possible within the Enel Grids Business Line and in compliance with any applicable laws, regulations and governance rules, including any stock exchange and unbundling-relevant provisions, which in any case prevail over the provisions contained in this document.



**Material specification code: GRI-GRI-MAT-E&C-0038**

Version no. 1 dated 21/04/2023.

**Subject: GSCM003 MV POLE MOUNTED SWITCH-DISCONNECTORS**

**Application Areas**

Perimeter: *Global*

Staff Function: -

Service Function: -

Business Line: *Enel Grids*

## 1.1 RELATED ORGANIZATIONAL DOCUMENTS TO BE IMPLEMENTED AT COUNTRY LEVEL

Within the corresponding geographical perimeter, each Enel Grids Company shall issue, under the supervision of Enel Grids Global Network Components, a detailed document in accordance with the provisions of this document.

## 2 DOCUMENT VERSION MANAGEMENT

Version	Date	Main changes description
0	21/01/2016	First Issuing of Global GSCM003 "MV POLE MOUNTED SWITCH-DISCONNECTORS" Material Specification
1	21/04/2023	SF6-free switchgear only. Added plug-in type switchgear without earthing-switches. Modified manual forwarded command to allow the use of padlock in service. Added support for surge arresters for bare conductor switchgear. Added VDIS for plug-in type switchgear with earthing-switches. Added a blocking mechanism to effectively block both manual and electric command by means of traction. (Direct command switchgear). Modified ratings and type tests according to IEC 62271 series

## 3 UNITS IN CHARGE OF THE DOCUMENT

Responsible for drawing up the document:

- ENEL Grids: Engineering and Construction / Components and Devices Design / Network Components / MV and LV Equipment unit.

Responsible for authorizing the document:

- ENEL Grids: Head of Networks Components unit
- ENEL Grids: Head of Quality unit.



**Material specification code: GRI-GRI-MAT-E&C-0038**

Version no. 1 dated 21/04/2023.

**Subject: GSCM003 MV POLE MOUNTED SWITCH-DISCONNECTORS**

**Application Areas**

Perimeter: *Global*

Staff Function: -

Service Function: -

Business Line: *Enel Grids*

## 4 REFERENCES

- Integrated Policy for Quality, Health and Safety, Environment, anti-Bribery and Information security.
- ISO 9001- Quality Management System – Requirements.
- ISO 14001 - Environmental Management System - Requirements with guidance for use
- ISO 45001 - Occupational Health and Safety Management System - Requirements with guidance for use.
- ISO 37001 - Anti-bribery Management System - Requirements with guidance for use
- Integrated Policy for Quality, Health and Safety, Environment, anti-Bribery and Information security.
- ISO 27001 - Information Security Management System – Requirements.
- Material specification MAT-O&M-NCS-2021-0033-EGIN “GSCG002 Technical Conformity Assessment”
- Working Instruction GRI-GRI-WKI-O&M-0020 “Contractual Requirements for Components and Materials Quality management” - ex WKI-QPT-CMQ-2020-0022.
- Construction Specification GRI-GRI-CNS-O&M-0002 “Barcode specification” – ex CNS-O&M-S&L-2021-0032-EGIN.
- Material Specification MAT-E&C-NC-2021-0046-EGIN “Outdoor Voltage Transformers up to Um 36 kV”.
- GSCC016 “Metal-oxide polymer-housed surge arresters without gaps for MV lines”.

Reference documents listed below (amendments included) shall be the edition in-force at the TCA request date.

- ISO/IEC 17000                      Conformity assessment – Vocabulary and general principles.
- ISO/IEC 17020                      General criteria for the operation of various types of bodies performing inspection.
- ISO/IEC 17025                      General requirements for the competence of testing and calibration laboratories.
- ISO/IEC 17050-1                    Conformity assessment - Supplier's declaration of conformity – Part 1: General requirements (ISO/IEC 17050-1:2004, corrected version 2007-06-15).
- ISO/IEC 17050-2                    Conformity assessment - Supplier's declaration of conformity - Part 2: Supporting documentation (ISO/IEC 17050-2:2004).

**Material specification code: GRI-GRI-MAT-E&C-0038**

Version no. 1 dated 21/04/2023.

**Subject: GSCM003 MV POLE MOUNTED SWITCH-DISCONNECTORS**
**Application Areas**

 Perimeter: *Global*

Staff Function: -

Service Function: -

 Business Line: *Enel Grids*

- IEC 62271-1 High-voltage switchgear and controlgear - Part 1: Common specifications For alternating current switchgear and controlgear).
- IEC 62271-200 High-voltage switchgear and controlgear - Part 200: AC metal-enclosed switchgear and controlgear for rated voltages above 1 kV and up to and including 52 kV.
- IEC 62271-102 High-voltage switchgear and controlgear - Part 102: Alternating current disconnectors and earthing switches.
- IEC 62271-103 High-voltage switchgear and controlgear - Part 103: Alternating current switches for rated voltages above 1 kV up to and including 52 kV.
- IEC 62271-214 High-voltage switchgear and controlgear - Part 214: Internal arc classification for metal-enclosed pole-mounted switchgear and controlgear for rated voltages above 1 kV and up to and including 52 kV.
- IEC 60529 Degrees of protection provided by enclosures (IP Code).
- IEC 62262 Degrees of protection provided by enclosures for electrical equipment Against external mechanical impacts (IK code).
- ISO 1461 Hot dip galvanized coatings on fabricated iron and steel articles. Specifications and test methods.
- ISO 14713-1 Zinc coatings - Guidelines and recommendations for the protection against corrosion of iron and steel in structures - Part 1: General principles of design and corrosion resistance.
- ISO 1183-1 Plastics -- Methods for determining the density of non-cellular plastics – Part 1: Immersion method, liquid pycnometer method and titration method.
- ISO 868 Plastics and ebonite - Determination of indentation hardness by means of a durometer (Shore hardness).
- ISO 9223 Corrosion of metals and alloys — Corrosivity of atmospheres — Classification, determination and estimation.
- IEC TR 62271-300 High-voltage switchgear and controlgear - Part 300: Seismic qualification of alternating current circuit-breakers.
- IEC 60587 Electrical insulating materials used under severe ambient conditions – Test methods for evaluating resistance to tracking and erosion.
- IEC 61621 Dry, solid insulating materials - Resistance test to high-voltage, low-current Arc discharges.
- IEC 62631-1 Dielectric and resistive properties of solid insulating materials - Part 1: General.

**Material specification code: GRI-GRI-MAT-E&C-0038**

Version no. 1 dated 21/04/2023.

**Subject: GSCM003 MV POLE MOUNTED SWITCH-DISCONNECTORS**
**Application Areas**

 Perimeter: *Global*

Staff Function: -

Service Function: -

 Business Line: *Enel Grids*

- IEC TS 62073                      Guidance on the measurement of hydrophobicity of insulator surfaces.
- IEC 60695-11-10                Fire hazard testing - Part 11-10: Test flames - 50 W horizontal and vertical flame test methods.
- IEC/TS 60815-3                 Selection and dimensioning of high-voltage insulators intended for use in polluted conditions - Part 3: Polymer insulators for a.c. systems.
- IEC 60068-2-52                 Environmental testing – Part 2-52: Tests – Test Kb: Salt mist, cyclic (sodium chloride solution).

**Reference laws**
**Spain**

- R.D. 614/2001, de 8 de junio, sobre disposiciones mínimas para la protección de la salud y seguridad de los trabajadores frente al riesgo eléctrico.
- R.D. 337/2014, de 9 de mayo, por el que se aprueban el Reglamento sobre condiciones técnicas y garantías de seguridad en instalaciones eléctricas de alta tensión y sus Instrucciones Técnicas Complementarias ITC-RAT 01 a 23.
- R.D. 223/2008, de 15 de febrero, por el que se aprueban el Reglamento sobre condiciones técnicas y garantías de seguridad en líneas eléctricas de alta tensión y sus instrucciones técnicas complementarias ITC-LAT 01 a 09.

**Colombia**

The switchgear must comply with the requirements established in the “Anexo General del RETIE Resolución 9 0708 de Agosto 30 de 2013 con sus Ajustes” and demonstrate this by means of a Certificate of Product Conformity.

**Group Pillar References**

- The Code of Ethics of Enel Group
- The Enel Group Zero Corruption Tolerance Plan (ZTC)
- Human Rights Policy
- Organization and Management Model as per Legislative Decree No. 231/2001



**Material specification code: GRI-GRI-MAT-E&C-0038**

Version no. 1 dated 21/04/2023.

**Subject: GSCM003 MV POLE MOUNTED SWITCH-DISCONNECTORS**

**Application Areas**

Perimeter: *Global*

Staff Function: -

Service Function: -

Business Line: *Enel Grids*

## 5 ORGANIZATIONAL PROCESS POSITION IN THE PROCESS TAXONOMY

Value Chain/Process Area: Engineering and Construction.

Macro Process: Devices and Components Development.

Process: Standard Catalog Management.

## 6 DEFINITIONS AND ACRONYMS

Acronym and Key words	Description
<b>Conformity assessment body</b>	Body that performs the conformity assessment activities [ISO 17000]
<b>Enel Equipment Key code</b>	It's an equipment representative for a group (family) of similar equipment chose by Enel
<b>Enel Equipment Family code</b>	Equipment belonging to a specific group (family) in which another equipment is identified as key code
<b>Manufacturer Product</b>	Component manufactured by a Supplier in accordance with a technical specification
<b>TCA systems</b>	The "conformity assessment systems", is applicable specifying that the rules and procedures to carry on the TCA are those specified in the present document
<b>TCA dossier</b>	Set of final documents delivered by the Supplier for the TCA
<b>TCA report</b>	Document describing the activities carried out for TCA
<b>Technical Conformity Assessment (TCA)</b>	A "conformity assessment" <sup>1</sup> with respect to "specified requirements" <sup>2</sup> consists in functional, dimensional, constructional and test characteristics required for a product (or a series of products) and quoted in technical specifications and quality requirements issued by Enel Group distribution companies. This also includes the verification of conformity with respect to local applicable regulation and laws and possession of relevant requested certifications

<sup>1</sup> Definition 2.1 of ISO/IEC 17000

<sup>2</sup> Definition 3.1 of ISO/IEC 17000

**Material specification code: GRI-GRI-MAT-E&C-0038**

Version no. 1 dated 21/04/2023.

**Subject: GSCM003 MV POLE MOUNTED SWITCH-DISCONNECTORS**
**Application Areas**

 Perimeter: *Global*

Staff Function: -

Service Function: -

 Business Line: *Enel Grids*

<b>Type A documentation</b>	Not confidential documents used for product manufacturing and management from which it is possible to verify the product conformity to all technical specification requirements, directly or indirectly
<b>Type B documentation</b>	Confidential documents used for product manufacturing and management where all product project details are described, in order to uniquely identify the product object of the TCA



**Application Areas**

Perimeter: *Global*  
 Staff Function: -  
 Service Function: -  
 Business Line: *Enel Grids*

**7 DESCRIPTION**

**7.1 LIST OF COMPONENTS**

Type code	Description
GSCM003/1	Manual pole mounted switch-disconnector 24 kV open terminals, direct command
GSCM003/2	Manual pole mounted switch-disconnector 24 kV open terminals, forwarded command
GSCM003/3	Motorized pole mounted switch-disconnector 24 kV open terminals, direct command
GSCM003/4	Motorized pole mounted switch-disconnector 24 kV open terminals, forwarded command
GSCM003/5	Manual pole mounted switch-disconnector 24 kV plug-in terminals, direct command, without earthing-switches
GSCM003/6	Manual pole mounted switch-disconnector 24 kV plug-in terminals, forwarded command, without earthing-switches
GSCM003/7	Motorized pole mounted switch-disconnector 24 kV plug-in terminals, direct command, without earthing-switches
GSCM003/8	Motorized pole mounted switch-disconnector 24 kV plug-in terminals, forwarded command, without earthing-switches
GSCM003/9	Manual pole mounted switch-disconnector 24 kV plug-in terminals, direct command, with earthing-switches
GSCM003/10	Motorized pole mounted switch-disconnector 24 kV plug-in terminals, direct command, with earthing-switches

**Table 2. Type codes for 24 kV**

Type code	Description
GSCM003/11	Manual pole mounted switch-disconnector 36 kV open terminals, direct command
GSCM003/12	Manual pole mounted switch-disconnector 36 kV open terminals, forwarded command
GSCM003/13	Motorized pole mounted switch-disconnector 36 kV open terminals, direct command
GSCM003/14	Motorized pole mounted switch-disconnector 36 kV open terminals, forwarded command
GSCM003/15	Manual pole mounted switch-disconnector 36 kV plug-in terminals, direct command, without earthing-switches
GSCM003/16	Manual pole mounted switch-disconnector 36 kV plug-in terminals, forwarded command, without earthing-switches
GSCM003/17	Motorized pole mounted switch-disconnector 36 kV plug-in terminals, direct command, without earthing-switches
GSCM003/18	Motorized pole mounted switch-disconnector 36 kV plug-in terminals, forwarded command, without earthing-switches
GSCM003/19	Manual pole mounted switch-disconnector 36 kV plug-in terminals, direct command, with earthing-switches
GSCM003/20	Motorized pole mounted switch-disconnector 36 kV plug-in terminals, direct command, with earthing-switches

**Table 3. Type codes for 36 kV**

**Application Areas**

Perimeter: *Global*  
 Staff Function: -  
 Service Function: -  
 Business Line: *Enel Grids*

Type code	Contry	Country Code	Terminals	Operation	Command	Earthing-switches
GSCM003/2	Italy	140500	Open	Manual	Forwarded	NO
GSCM003/2	Spain	140968	Open	Manual	Forwarded	NO
GSCM003/2	Romania	140224	Open	Manual	Forwarded	NO
GSCM003/3	Peru	141961	Open	Electric	Direct	NO
GSCM003/3	Chile	141974	Open	Electric	Direct	NO
GSCM003/3	Argentina	0104-0517	Open	Electric	Direct	NO
GSCM003/3	Colombia	141964	Open	Electric	Direct	NO
GSCM003/3	Brazil	141971	Open	Electric	Direct	NO
GSCM003/4	Italy	140501	Open	Electric	Forwarded	NO
GSCM003/4	Spain	140978	Open	Electric	Forwarded	NO
GSCM003/4	Romania	140223	Open	Electric	Forwarded	NO
GSCM003/6	Spain	140969	Plug-in	Manual	Forwarded	NO
GSCM003/7	Chile	141972	Plug-in	Manual	Direct	NO
GSCM003/7	Colombia	141965	Plug-in	Manual	Direct	NO
GSCM003/7	Brazil	141966	Plug-in	Manual	Direct	NO
GSCM003/8	Spain	140976	Plug-in	Electric	Forwarded	NO
GSCM003/9	Italy	140502	Plug-in	Manual	Direct	YES
GSCM003/9	Spain	140975	Plug-in	Manual	Direct	YES
GSCM003/9	Romania	140222	Plug-in	Manual	Direct	YES
GSCM003/9	Peru	141963	Plug-in	Manual	Direct	YES
GSCM003/10	Italy	140503	Plug-in	Electric	Direct	YES
GSCM003/10	Spain	140973	Plug-in	Electric	Direct	YES
GSCM003/10	Romania	140218	Plug-in	Electric	Direct	YES
GSCM003/10	Peru	141962	Plug-in	Electric	Direct	YES
GSCM003/10	Chile	141976	Plug-in	Electric	Direct	YES
GSCM003/10	Brazil	141970	Plug-in	Electric	Direct	YES

**Table 4. List of components 24 kV**

Type code	Contry	Country Code	Terminals	Operation	Command	Earthing-switches
GSCM003/12	Spain	140977	Open	Manual	Forwarded	NO
GSCM003/13	Chile	141973	Open	Manual	Direct	NO
GSCM003/13	Argentina	0104-0518	Open	Manual	Direct	NO
GSCM003/13	Brazil	141969	Open	Manual	Direct	NO
GSCM003/14	Spain	140972	Open	Electric	Forwarded	NO
GSCM003/16	Spain	140979	Plug-in	Manual	Forwarded	NO
GSCM003/17	Chile	140975	Plug-in	Manual	Direct	NO
GSCM003/17	Brazil	141968	Plug-in	Manual	Direct	NO
GSCM003/18	Spain	140974	Plug-in	Electric	Forwarded	NO
GSCM003/19	Spain	140971	Plug-in	Manual	Direct	YES
GSCM003/20	Spain	140970	Plug-in	Electric	Direct	YES
GSCM003/20	Chile	141977	Plug-in	Electric	Direct	YES
GSCM003/20	Brazil	141967	Plug-in	Electric	Direct	YES

**Table 5. List of components 36 kV**

**Material specification code: GRI-GRI-MAT-E&C-0038**

Version no. 1 dated 21/04/2023.

**Subject: GSCM003 MV POLE MOUNTED SWITCH-DISCONNECTORS****Application Areas**Perimeter: *Global*

Staff Function: -

Service Function: -

Business Line: *Enel Grids***7.2 SERVICE CONDITIONS****7.2.1 General service conditions**

Clause 4.1.3 of IEC 62271-1 is applicable with the following additions.

Maximum reference altitude for Colombia	2.700 m
Pollution level (IEC/TS 60815-3)	e "Very Heavy"
Climatic category type (ISO 9223 and ISO 14713-1)	C5 "Very High".
Minimum and maximum air temperature	-25°C / +45°C
Relative humidity	98%
Network neutral earthing systems	Effectively earthed neutral system Non effectively earthed neutral system

**Table 6. Service Conditions**

The Manufacturer shall provide de-ratings table related to altitudes up to 3.000 m for specific installations.

**7.2.2 Seismic qualification level**

For the countries below, it shall be considered the following considerations upon the seismic qualification level:

<b>Country</b>	<b>Standard (LEVEL)</b>
Colombia	IEC/TR 62271-300 (AF5) + Reglamento Colombiano de Construcción sismo resistente
Chile	IEC/TR 62271-300 (AF5) + ETGI-1020
Peru	IEC/TR 62271-300 (AF5)

**Table 7. Seismic qualification level**

**Material specification code: GRI-GRI-MAT-E&C-0038**

Version no. 1 dated 21/04/2023.

**Subject: GSCM003 MV POLE MOUNTED SWITCH-DISCONNECTORS****Application Areas**Perimeter: *Global*

Staff Function: -

Service Function: -

Business Line: *Enel Grids***7.3 TECHNICAL CHARACTERISTICS**

The switch-disconnector shall be manufactured in compliance with the reference national laws and with the standards pointed out in chapter 4.

Table 8 shows the general requirements that all switch-disconnector shall observe.

Characteristics of the switchgear			
Rated voltage ( $U_r$ )		[kV]	<b>24</b> <b>36</b>
Rated insulation level	- Rated short-duration power-frequency withstand voltage (Common value)	[kV]	50      70
	- Rated short-duration power-frequency withstand voltage (Across the isolating distance)	[kV]	60      80
	- Rated lightning impulse withstand voltage (Common value)	[kV]	125      170
	- Rated lightning impulse withstand voltage (Across the isolating distance)	[kV]	145      195
Rated frequency ( $f_r$ )		[Hz]	50 and 60
Rated continuous current ( $I_r$ )		[A]	630
Rated short-time withstand current ( $I_k$ )		[kA]	16
Rated short-time phase-to-earth withstand current ( $I_{ke}$ )		[kA]	16
Rated peak withstand current ( $I_p$ )		[kA]	40 and 41,6
Rated peak phase-to-earth withstand current ( $I_{pe}$ )		[kA]	40 and 41,6
Rated duration of short-circuit ( $t_k$ )		[s]	1
Rated duration of phase-to-earth short-circuit ( $t_{ke}$ )		[s]	1
Rated supply voltage of auxiliary and control circuits ( $U_a$ )		[V]	24 (-15% +20%)
External degree of protection			IP54
Internal arc test	Arc fault current	[kA]	16
	Arc fault duration	[s]	0,5
Maximum weight		[kg]	200

**Material specification code: GRI-GRI-MAT-E&C-0038**

Version no. 1 dated 21/04/2023.

**Subject: GSCM003 MV POLE MOUNTED SWITCH-DISCONNECTORS****Application Areas**Perimeter: *Global*

Staff Function: -

Service Function: -

Business Line: *Enel Grids*

Characteristics of the switch-disconnector			
Rated voltage ( $U_r$ )	[kV]	<b>24</b>	<b>36</b>
Rated mainly active load-breaking current ( $I_{load}$ )	[A]	630	
Rated cable-charging breaking current ( $I_{cc}$ )	[A]	16	20
Rated line-charging breaking current ( $I_{lc}$ )	[A]	1,5	2
Rated earth fault breaking current ( $I_{ef1}$ )	[A]	48	60
Rated cable- and line-charging breaking current under earth fault conditions ( $I_{ef2}$ )	[A]	28	35
Rated short-circuit making current ( $I_{ma}$ )	[kA]	40 and 41,6	
Mechanical endurance class		M2	
Electrical endurance class		E3	
Characteristics of the earthing-switches			
Rated voltage ( $U_r$ )	[kV]	<b>24</b>	<b>36</b>
Rated short-circuit making current ( $I_{ma}$ )	[kA]	40 and 41,6	
Mechanical endurance class		M0	
Electrical endurance class		E2	

**Table 8. Ratings of the switchgear****7.4 GENERAL CHARACTERISTICS OF THE SWITCHGEAR****7.4.1 Enclosure**

The enclosure shall be made of stainless steel AISI 316 and strong enough to support dynamic short circuit forces and the vibration of the switch-disconnector during operation and for transportation. Equivalent stainless steel could be proposed to ENEL approval.

All enclosure surfaces shall be passivated to prevent the effects of corrosion. Special attention should be paid to the passivation of the weld beads so that they are free of rust or other impurities that affect the color of the passivation.

**Material specification code: GRI-GRI-MAT-E&C-0038**

Version no. 1 dated 21/04/2023.

**Subject: GSCM003 MV POLE MOUNTED SWITCH-DISCONNECTORS****Application Areas**Perimeter: *Global*

Staff Function: -

Service Function: -

Business Line: *Enel Grids*

The enclosure shall be constructed in such a way as not to allow water to accumulate. For this purpose, after installation, the switch-disconnector shall be oblique towards the pole of 3 degrees to avoid the stagnation of humidity.

The insulating medium shall be SF6-free gas. Solid insulation switchgears (SIS) could be accepted as long as compliant with IEC 62271 series and under previous ENEL approval.

The enclosure shall be a sealed pressure system (IEC 62271-1).

The expecting operating life about leakage performance shall be 40 years.

The enclosure shall have an overpressure valve, equipped with a metallic disc for the protection against accidental strains, placed at a proper distance from the valve itself and equipped with lateral grids which allow the gas vent and prevent the fall of material to the ground. The valve shall not be put in the operation sides of the switch-disconnector (e.g., motorization side, cable side, lever side) and shall be protected against water infiltration.

The panels for the accessing the mechanical parts of the switch-disconnector shall be removable without removing parts of the commands; it is allowed only removing the extensions of the operating shafts of the switch-disconnector and of the earthing switches.

A connector for connecting the earthing cable shall be located on the bottom of the enclosure or on the fixing structure. The connector shall allow the connection of cables with sections between 16 and 50 mm<sup>2</sup>.

#### **7.4.2 Lifting lugs**

Attachment points for lifting the switch-disconnector shall be provided to permit lifting and installation in accordance with the manufacturer's instructions. They shall be designed and located on the upper part of the enclosure to avoid interference between lifting slings and any attachments (bushings, operating handles, etc.), and to avoid scratching or marring the enclosure finish during handling.

#### **7.4.3 Support structure**

The switch-disconnector shall be provided with the standardized bracket to be attached to the pole according to Annex B.

The switchgear shall be provided with coupling supports according to figure 1.

**Material specification code: GRI-GRI-MAT-E&C-0038**

Version no. 1 dated 21/04/2023.

**Subject: GSCM003 MV POLE MOUNTED SWITCH-DISCONNECTORS****Application Areas**Perimeter: *Global*

Staff Function: -

Service Function: -

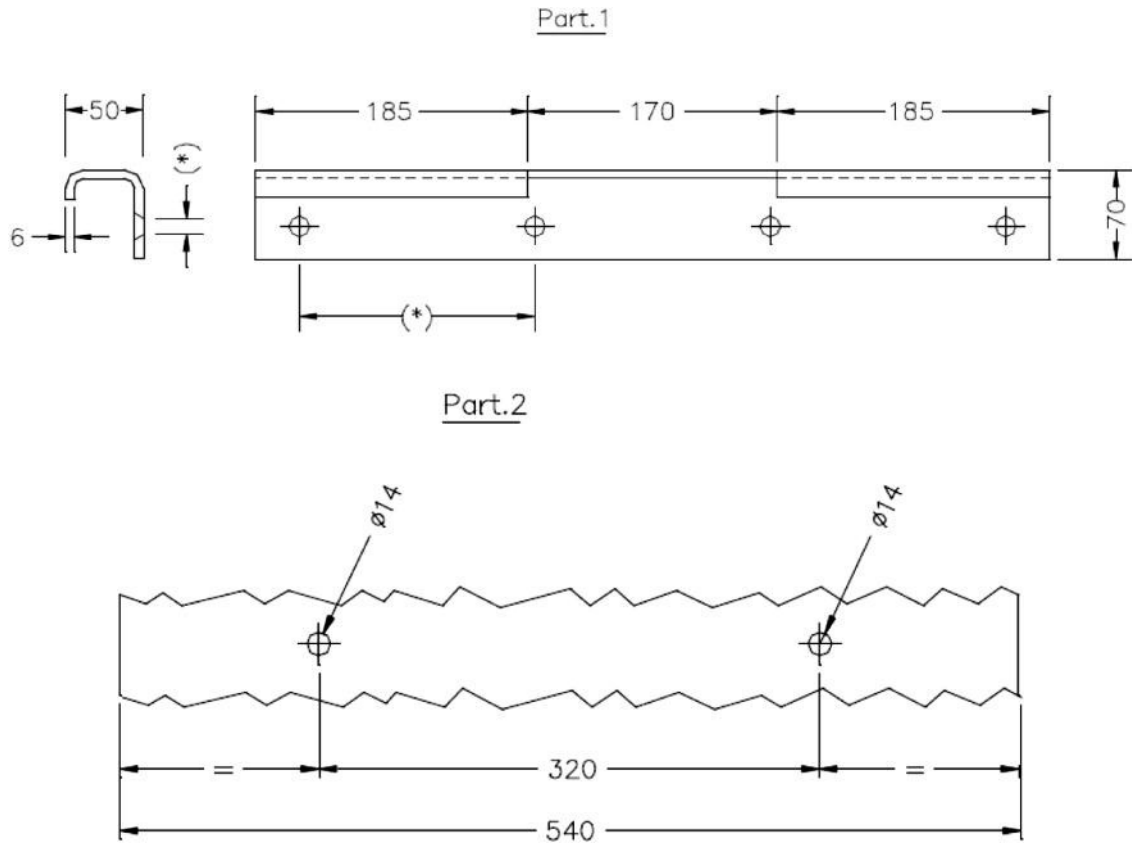
Business Line: *Enel Grids***Figure 1. Switchgear coupling support.**

\* The number and size of the holes for fixing the equipment and the center-to-center distance shall be stated by the Manufacturer to ensure the stability of the structure with a weight which is the double of the normal weight of the equipment, including the voltage transformer (see chapter 7.4.4).

**7.4.3.1 Requirements for Colombia**

The switch-disconnector shall be designed also to be installed on a horizontal surface, as shown in the figure 2.

**Material specification code: GRI-GRI-MAT-E&C-0038**

Version no. 1 dated 21/04/2023.

**Subject: GSCM003 MV POLE MOUNTED SWITCH-DISCONNECTORS**
**Application Areas**

 Perimeter: *Global*

Staff Function: -

Service Function: -

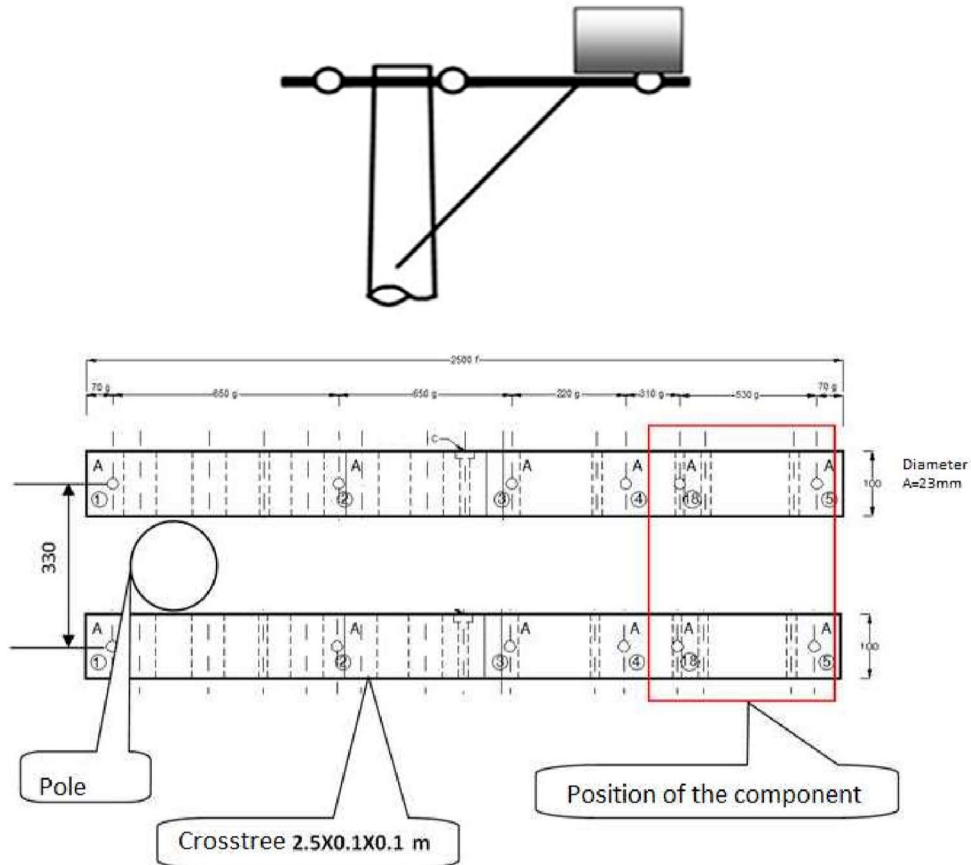
 Business Line: *Enel Grids*

**Figure 2. Switchgear in horizontal surface for Colombia**
**7.4.3.2 Requirements for Chile**

The support must be “Clamp type” (see Figure 3) to avoid the use of metal straps that could damage the pole.





**Material specification code: GRI-GRI-MAT-E&C-0038**

Version no. 1 dated 21/04/2023.

**Subject: GSCM003 MV POLE MOUNTED SWITCH-DISCONNECTORS**

**Application Areas**

Perimeter: *Global*

Staff Function: -

Service Function: -

Business Line: *Enel Grids*

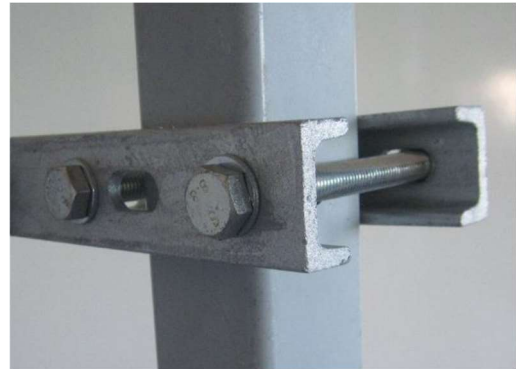
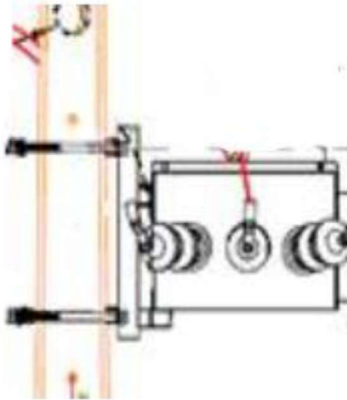

**Figure 3. Clamp-type support for Chile**

The cross section of the pole at that point is the one indicated in Figure 4 (distances in mm)

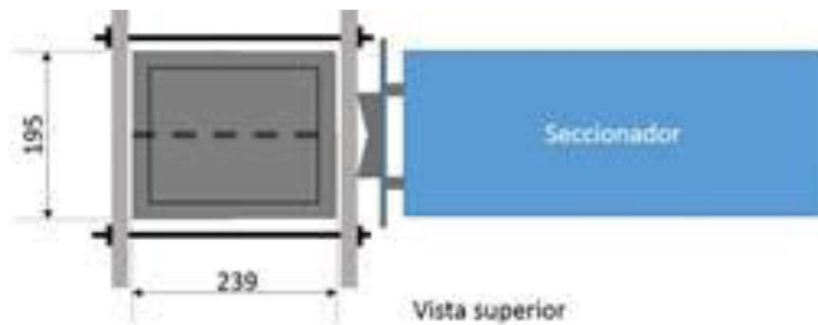

**Figure 4. Cross section of pole for Chile**

#### 7.4.4 Support for voltage transformer

On top of the switch-disconnector it shall be provided a fixing system to allow the installation of the outdoor voltage transformer described in the Global Standard GSCT004. During the design and manufacturing of the switch-disconnector, the maximum weight of this transformer shall also be considered for strains during operation, transportation and installation.



**Material specification code: GRI-GRI-MAT-E&C-0038**

Version no. 1 dated 21/04/2023.

**Subject: GSCM003 MV POLE MOUNTED SWITCH-DISCONNECTORS**

**Application Areas**

Perimeter: *Global*

Staff Function: -

Service Function: -

Business Line: *Enel Grids*

#### 7.4.5 Operating directions for commands

In the command with rotational movement, the operation direction shall be compliant with the IEC 60447. For each operating place, it shall be written the function of the device, the movement direction and the "open" or "closed" signal positions, which must be visible from the ground, even in the case of installation on a horizontal surface (Colombia).

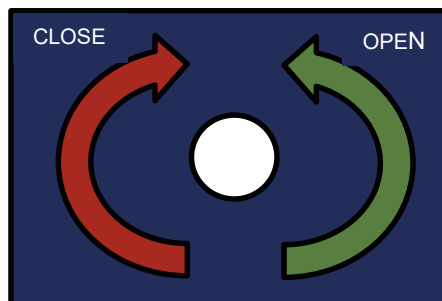

**Figure 5. Operating directions**

#### 7.4.6 Position indication

The switch-disconnector and the earthing switches shall be equipped with "safe position devices" for the indication of the real position of the main moving contacts of the switches, as required by IEC 62271-200 and IEC 62271-102.

The indicators of the positions shall be luminescent and protected from the action of weather by adopting a transparent protection and shall be of an adequate dimension to be clearly visible from the ground. It is allowed for that a lenticular transparent protection.

Near the indicators, nameplates shall be applied.

These nameplates, for "switch-disconnector" (SD) and "earthing switches" (ES1 and ES2), shall be on white background with black RAL 9005 characters to facilitate their identification.

For the position indication, the following shall be provided:

- Switch-disconnector's signal position, through the following symbology:
  - black letter "I" on 3000 RAL F2 red background corresponding to the close position of the switch-disconnector.
  - black letter "O" on 6017 RAL F2 green background corresponding to the open position of the switch-disconnector.



**Material specification code: GRI-GRI-MAT-E&C-0038**

Version no. 1 dated 21/04/2023.

**Subject: GSCM003 MV POLE MOUNTED SWITCH-DISCONNECTORS**

**Application Areas**

Perimeter: *Global*

Staff Function: -

Service Function: -

Business Line: *Enel Grids*

- Earthing-switch's signal position. The used device shall be mechanically interlocked with the main circuit moving contacts and the correspondent position shall be displayed through the following symbology:
  - black letter "I" on 1021 RAL F2 yellow background corresponding to the close position of the earthing-switch.
  - black letter "O" on 7030 RAL F2 grey background corresponding to the open position of the earthing-switch.

The signal positions shall be visible even with the protection shell removed.

#### 7.4.7 Surfaces treatment

All the external metallic parts which are not in stainless steel shall be designed to be used in environments of climatic category type C5 "Very High", in compliance with standards ISO 9223 and ISO 14713-1.

They shall be protected with a hot dip galvanization process according to ISO 1461 with a minimum thickness of 140 µm. The zinc coating will be uniform and continuous, perfectly adhered to withstand all the stresses of normal use without cracking or peeling.

After galvanizing, the treated surfaces will not be subjected to any process that may affect the continuity or uniformity of the protective coating, complying with the standardized thicknesses.

To verify the adequate surface treatment IEC 60068-2-52, test method 6 (chapter 9.4.7) type test shall be performed. As a result of this test, the surface treatment shall not present a significant degradation of its characteristics.

The manufacturer shall justify the treatment used in the TCA dossier.

#### 7.4.8 Rating plates

Each switchgear shall have two stainless steel AISI 316 rating plates in the language of the Country in which it has to be delivered. One rating plate shall have four eyelets for fixing it at the base of the pole with a stainless-steel band or it shall be provided with a support to put on the pole. The other rating plate shall be placed on the switch-disconnector.

The rating plate shall contain information on the code that the Manufacturer assigns to each series of the same type. It shall contain the mandatory information required by IEC 62271-200 (table 101), the Enel Group type code (see tables 2 and 3) and the local components codification (see tables 4 and 5).



**Material specification code: GRI-GRI-MAT-E&C-0038**

Version no. 1 dated 21/04/2023.

**Subject: GSCM003 MV POLE MOUNTED SWITCH-DISCONNECTORS**

**Application Areas**

Perimeter: *Global*

Staff Function: -

Service Function: -

Business Line: *Enel Grids*

In the proximity of the rating plate, it must be put a barcode with the characteristics described in GRI-GRI-CNS-O&M-0002 "Barcode specification."

Only for Colombia on the rating plate there shall be also the Customer's Name.

#### **7.4.9 Operating sequence nameplate and synoptic scheme**

The switch-disconnector shall be equipped with a stainless steel AISI 316 "operating sequence nameplate" on which there shall be the sequence of operations to be executed, for the put in service. It shall also contain the switch-disconnector's electric scheme. This nameplate shall be positioned on the protective shell of each command to be clearly visible.

#### **7.4.10 Manometer**

To verify the SF6 pressure, a manometer shall be provided.

The manometer shall not be extractable and, in supply normal conditions, the pressure indication shall be between 25% and 75% of the area marked as safe. The area marked as safe shall be green whereas the other area shall be red. It must be visible from the bottom of the pole.

The manometer shall have temperature correction of the indication.

#### **7.4.11 Marks on the phases**

In correspondence of each bushing, the marks R – S – T to identify the three different phases shall be applied. These marks shall be designed to be used in environments of climatic category type C5 "Very High" (ISO 14713-1)

#### **7.4.12 Instruction manual and maintenance**

The switchgear shall have an instruction manual in local language in accordance with the point 10.4 of IEC 62271-1 and with the following indications.

The switchgear shall be maintenance free for the entire expected service life (40 years), excluding the following admitted activities:

- An electrical operation, with a periodicity not less than 1 year
- A visual inspection from the ground, with a periodicity not less than 5 years



**Material specification code: GRI-GRI-MAT-E&C-0038**

Version no. 1 dated 21/04/2023.

**Subject: GSCM003 MV POLE MOUNTED SWITCH-DISCONNECTORS**

**Application Areas**

Perimeter: *Global*

Staff Function: -

Service Function: -

Business Line: *Enel Grids*

- Condition-based maintenance, e.g. following the above listed periodical activities

These statements shall be written in the instruction manual.

## 7.5 SWITCH-DISCONNECTOR FOR BARE CONDUCTOR LINES

This component has just the switch-disconnector for opening and closing the line. The functional electric scheme is shown in Figure 6.

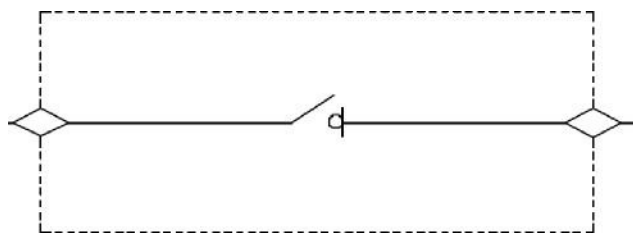

**Figure 6. Functional scheme for switch-disconnector for bare conductor lines**

The three-pole manual or motorized operating device of the switch-disconnector shall be dead center overcoming both in opening and closing operation.

### 7.5.1 Polymeric insulators

The housing (sheath and sheds) of the polymeric insulators shall be HTV (High Temperature Vulcanized) solid silicone type. Other type of silicone will be accepted if it maintains same or better properties than listed in table 9.

Two fabrication processes are allowed for the silicone rubber considered in the standard, molding process or by assembling modules.

**Material specification code: GRI-GRI-MAT-E&C-0038**

Version no. 1 dated 21/04/2023.

**Subject: GSCM003 MV POLE MOUNTED SWITCH-DISCONNECTORS****Application Areas**Perimeter: *Global*

Staff Function: -

Service Function: -

Business Line: *Enel Grids*

The characteristics of the silicone-rubber are described in table 9.

<b>Mechanic characteristics</b>	<b>Standard</b>	<b>Unit</b>	<b>Minimum value HTV</b>
Density	ISO 1183-1	g/cm <sup>3</sup>	1,5
Hardness	ISO 868	Shore A	65
Breaking stress	ISO 37	N/mm <sup>2</sup>	3,5
Breaking elongations	ISO 37	%	200
Tear strength	ISO 34-1	N/mm <sup>2</sup>	12

**Table 9. Silicone-rubber characteristics**

At every existing interface from the composite insulator, the adhesion strength of the interface (interface resistance) shall be higher than the tear strength of the silicone.

Silicone-rubbers of insulators shall have a resistance to tracking and electric erosion with a classification of Class 1A 4,5 according to IEC 60587 and shall resist the effects of corona discharges and ozone. It shall withstand a low-current arc discharge for more than 300 seconds under the conditions indicated in standard IEC 61621 and its volume resistivity shall be over 1010  $\Omega \cdot m$  according to IEC 62631-1.

The silicone-rubber shall be type V0 according to the IEC 60695-11-10.

Additionally, the silicone-rubber shall have highly hydrophobic features and shall be classified type WC1 as specified in IEC TS 62073.

The minimum creepage distance of the insulators shall be according to the rated voltage and the pollution level assigned, considering RUSCD = 60 mm/kV for 24 kV (831 mm creepage distance) and RUSCD = 53,7 mm/kV for 36 kV (1116 mm creepage distance).

The insulators shall resist a bending movement at the base of attack of at least 250 Nm and to resist an adequate torque to hold the conductors.

All the characteristics and type test on the insulators shall be included in the TCA documentation.

**Material specification code: GRI-GRI-MAT-E&C-0038**

Version no. 1 dated 21/04/2023.

**Subject: GSCM003 MV POLE MOUNTED SWITCH-DISCONNECTORS**
**Application Areas**

 Perimeter: *Global*

Staff Function: -

Service Function: -

 Business Line: *Enel Grids*
**7.5.2 End fitting of polymeric insulators**

The far end of the internal conductor shall be threaded M16x2x60. It shall have the proper surface treatment in order to allow the connection of aluminum connectors.

For the switchgears to be delivered in Spain, Argentina, Chile, Colombia and Peru, the insulator shall allow the connection of the eyelet terminal according to Figure 7.

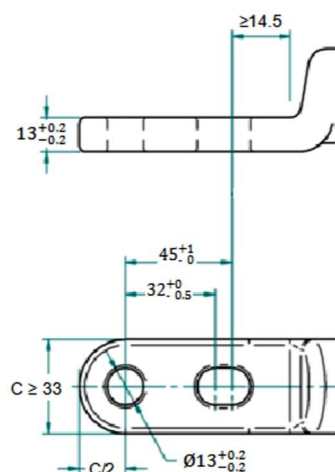
**Figure 7. Eyelet terminal**

In order to allow the connection, a nickel-plated copper plate should be fixed at the end of thread in vertical position. This plate shall be installed and properly secured with the appropriate torque in the manufacturer's factory. An example of the plate is shown in Figure 8.

**Material specification code: GRI-GRI-MAT-E&C-0038**

Version no. 1 dated 21/04/2023.

**Subject: GSCM003 MV POLE MOUNTED SWITCH-DISCONNECTORS**

**Application Areas**

Perimeter: *Global*

Staff Function: -

Service Function: -

Business Line: *Enel Grids*

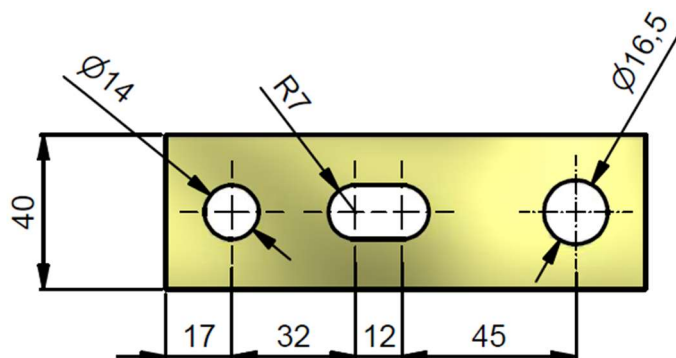

**Figure 8. Example of connection plate**

### 7.5.3 Support for surge arresters

The enclosure of the switchgear shall have supports that allow the installation of surge arresters according global Standard GSCC016. The surge arresters shall be installed parallel to the insulators in line and load sides. An example of the surge arresters installation is shown in Figure 9.

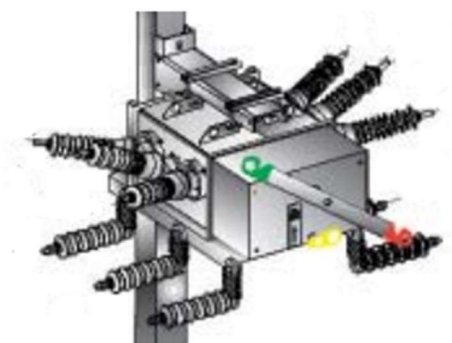

**Figure 9. Example of support for surge arresters**

### 7.5.4 Forwarded manual command.

This type of manual command applies only for the switch-disconnectors to be delivered to Italy, Spain and Romania.

It must be created to allow both the opening and the closing operation by rotational movement made from the base of the pole. The forwarded command shall be made by means of a single tubular metallic system along the pole.



**Material specification code: GRI-GRI-MAT-E&C-0038**

Version no. 1 dated 21/04/2023.

**Subject: GSCM003 MV POLE MOUNTED SWITCH-DISCONNECTORS**
**Application Areas**

 Perimeter: *Global*

Staff Function: -

Service Function: -

 Business Line: *Enel Grids*

It is necessary to consider a distance between 7 m and 15 m from the forwarded local command to the switch-disconnector.

The forwarded control must have an adequate fastening system to be used in any pole used in the Distribution Companies of ENEL group.

**FORWARDED MANUAL COMMAND FOR NON-TELECONTROLLED SWITCHGEAR**

The manual command shall have two stable positions:

- Open position: In this position, the switch-disconnector is in open state.
- Close position: In this position, the switch-disconnector is in closed state.

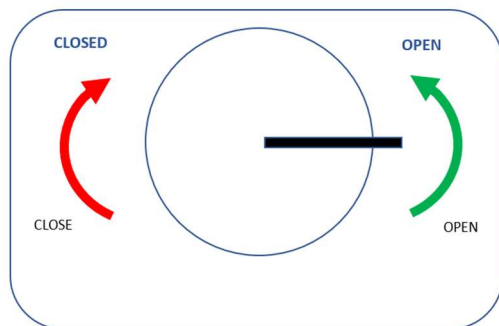

**Stable open position**

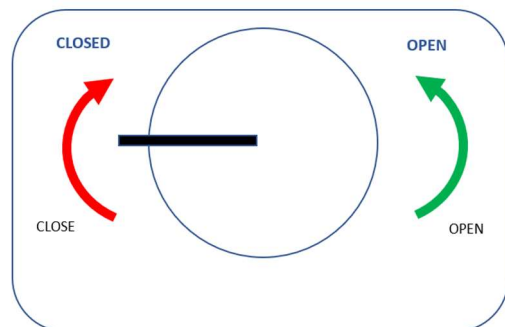

**Stable closed position**

The manual command shall be designed to allow the application of a lock with an arc of 8 mm thickness in both positions to block it.

**FORWARDED MANUAL COMMAND FOR TELECONTROLLED SWITCHGEAR**

The manual operation of the switch-disconnector shall be available in every moment, independently from the motorized command.

The manual command shall have three stable positions:

- Open position: In this position, the switch-disconnector is in open state and the electric command (local and remote) is disabled.

**Material specification code: GRI-GRI-MAT-E&C-0038**

Version no. 1 dated 21/04/2023.

**Subject: GSCM003 MV POLE MOUNTED SWITCH-DISCONNECTORS**
**Application Areas**

 Perimeter: *Global*

Staff Function: -

Service Function: -

 Business Line: *Enel Grids*

- Remote position: In this position, the switch-disconnector can be in the open or in the closed position. Electric command is always allowed in this position.
- Close position: In this position, the switch-disconnector is in closed state and the electric command (local and remote) is disabled.

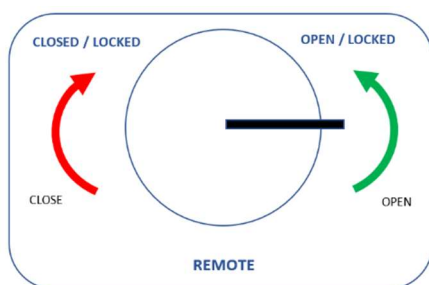
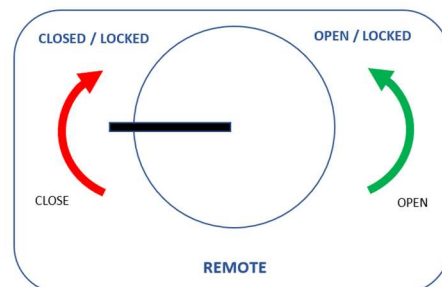
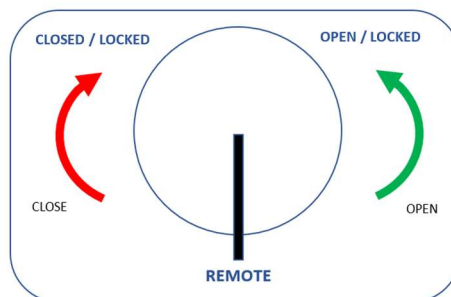
**Stable open/locked position**

**Stable closed/locked position**

**Stable remote position**

The manual command shall be designed to allow the application of a lock with an arc of 8 mm thickness in all the three positions on the manual command in order to block it.

The manual operation must prevent the motorized command.

### 7.5.5 Direct manual command

The switch-disconnector shall be directly operated by a lever located in the frontal part of the enclosure. The manual operation shall be made from the ground by means of an insulated stick applying a downward strength that doesn't exceed 200 N.

**Material specification code: GRI-GRI-MAT-E&C-0038**

Version no. 1 dated 21/04/2023.

**Subject: GSCM003 MV POLE MOUNTED SWITCH-DISCONNECTORS**
**Application Areas**

 Perimeter: *Global*

Staff Function: -

Service Function: -

 Business Line: *Enel Grids*

The lever of the switch-disconnector shall be red RAL 3026 in the part of the lever used for the closing operation and green RAL 6038 in the part of the lever used for the opening operation and shall have a nameplate with the characters "SD" referring to the switch-disconnector in black RAL 9005 on white RAL 9010 background.

The lever may be taken away to remove the front panel. The lever shall be removed for transportation.

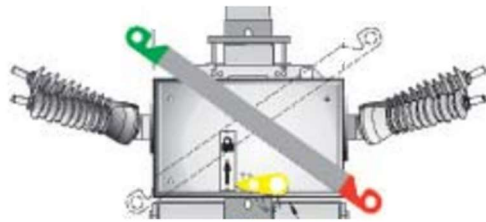

**Figure 10. Color reference for lever**

The direct manual command shall have two stable positions:

- Open position: In this position, the switch-disconnector is in open state.
- Close position: In this position, the switch-disconnector is in closed state.

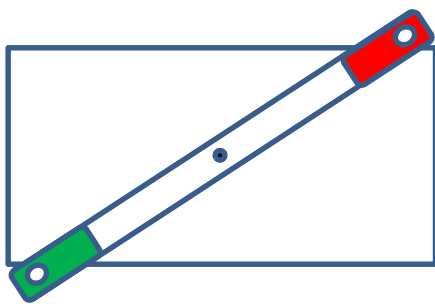

**Stable open position**

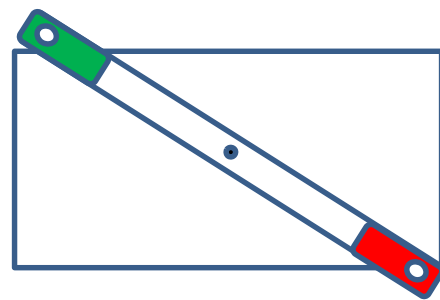

**Stable closed position**

To effectively block both manual and electric command, a blocking mechanism shall be designed that acts by means of traction. This mechanism shall be placed in the bottom part of the enclosure and shall be activated and deactivated by means of an insulated stick applying a downward strength that doesn't exceed 200 N.

**Material specification code: GRI-GRI-MAT-E&C-0038**

Version no. 1 dated 21/04/2023.

**Subject: GSCM003 MV POLE MOUNTED SWITCH-DISCONNECTORS**
**Application Areas**
Perimeter: *Global*

Staff Function: -

Service Function: -

Business Line: *Enel Grids*

### 7.5.6 Electric command

The switch-disconnector with electric command shall be operated by an electric motor, suitable for continuous service, having the following characteristics:

Supply voltage	[V <sub>cc</sub> ]	24 +20% -15%
Power consumption at full speed	[W]	≤ 300
Degree of protection		≥ IP3X

**Table 10. Characteristics of electric command**

The motor shall be of the dead point exceeding type with the following functional characteristics:

- the stability of the position of the switch-disconnector contacts must be ensured until the dead center has been exceeded.
- if, during any operation, a power failure occurs before the dead center is exceeded, the system must allow the kinematic mechanism to be reset to its initial position.
- the motorization circuit must not absorb any current when it is in the stand-by state.

The motorized command of the switch-disconnector shall allow the possibility to install the manual command and to substitute the electronic board and the electric motor in an easy way and without removing the switch-disconnector.

The connection cable between switch-disconnector and Peripheral Unit (UP), to be supplied with the switch-disconnector, shall be 10x1,5 mm<sup>2</sup> outdoor type, 10 m long. Only for the switch-disconnectors to be delivered for Spain, the connection cable between switch-disconnector and Peripheral Unit (UP) shall be 10x2,5 mm<sup>2</sup> outdoor type, 20 m long.

Both the extremities of this cable shall have pre-isolated terminals for the terminal box used and identification marks according to the connection in Annex A.

This cable shall be prepared joining two conductors in parallel for each polarity of the power circuit, mechanically joint by a heat shrinking for a minimum length of 20 cm. Every necessary hole for cable passage shall have appropriate cable gland to restore the degree of protection of the enclosure (IEC 60529).

The total resistance (LV cable + coil) of open and close command circuit shall be between 5 and 5000 Ω in all environmental conditions according to limits of the ambient temperature.



**Material specification code: GRI-GRI-MAT-E&C-0038**

Version no. 1 dated 21/04/2023.

**Subject: GSCM003 MV POLE MOUNTED SWITCH-DISCONNECTORS**

**Application Areas**

Perimeter: *Global*

Staff Function: -

Service Function: -

Business Line: *Enel Grids*

## 7.6 SWITCH-DISCONNECTOR FOR CABLE LINES

This component has a switch-disconnector for opening and closing the line and optionally two earthing-switches to put into ground both sides of the switchgear. The functional electric schemes are the ones of the Figures 11 and 12.

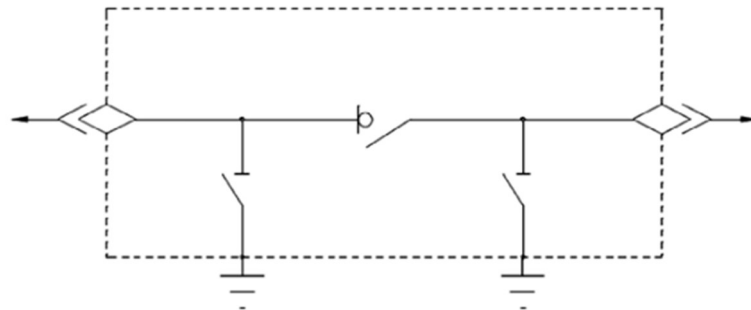

**Figure 11. Plug-in switch-disconnector with earthing-switches**

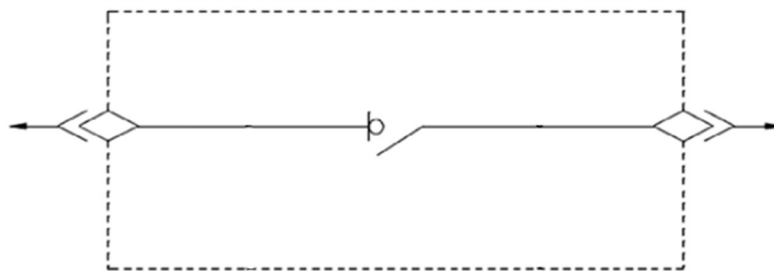

**Figure 12. Plug-in switch-disconnector without earthing-switches**

### 7.6.1 Bushings

To connect the MV cable terminals, the switch-disconnector shall be equipped with outdoor cone bushings in accordance with EN 50181. Bushings shall have 630 A rated normal current (type C interface). To connect the MV cable to the bushings, symmetrical T-separable connectors shall be used.

**Material specification code: GRI-GRI-MAT-E&C-0038**

Version no. 1 dated 21/04/2023.

**Subject: GSCM003 MV POLE MOUNTED SWITCH-DISCONNECTORS**
**Application Areas**

 Perimeter: *Global*

Staff Function: -

Service Function: -

 Business Line: *Enel Grids*

In order to avoid that the cable weight interferes with the bushing resistance, a support shall be provided on the bottom of the switch-disconnector (the support may be removable for transportation). The height between the axis of the bushing and the support shall be at least 420 mm.

The support shall have a tension clamp, for each cable according to the Global Standard GSC001, to transmit the mechanical tension in the cable to the supporting structure.

### 7.6.2 Direct manual command for switchgears with earthing-switches

For the manual operation:

- The switch-disconnector shall be directly operated by a lever located in the frontal part of the enclosure. The operation shall be made from the ground by means of an insulated stick applying a downward strength that doesn't exceed 200 N.  
The lever of the switch-disconnector to open or close the line shall be red RAL 3026 (e.g., polyurethane paint) and shall have a nameplate with the characters "SD" referring to the switch-disconnector in black RAL 9005 on white RAL 9010 background.
- Each earthing-switch shall be directly operated by a lever located in the frontal part of the enclosure. The operation shall be made from the ground by means of an insulated stick applying a downward strength that doesn't exceed 200 N.  
The two earthing switches, which are independent between them, must be moved only with the switch-disconnector in open position.  
The earthing-switches levers shall be located one on each side of the switch-disconnector lever.  
The levers of both earthing-switches shall be yellow RAL 1026 (e.g., polyurethane paint) and shall have a nameplate with the characters "ES1" and "ES2" in black RAL 9005 on white RAL 9010 background.

The levers may be taken away in order to remove the front panel. Their assembling must be allowed only in an obliged position, to avoid that they can be exchanged between them and with that one of the switch-disconnector. The levers shall be removed for transportation.

The direct manual command of the switch-disconnector or earthing-switches shall have two stable positions:

- Open position: In this position, the switch-disconnector or the earthing-switch is in open state.



**Material specification code: GRI-GRI-MAT-E&C-0038**

Version no. 1 dated 21/04/2023.

**Subject: GSCM003 MV POLE MOUNTED SWITCH-DISCONNECTORS**

**Application Areas**

Perimeter: *Global*

Staff Function: -

Service Function: -

Business Line: *Enel Grids*

- Close position: In this position, the switch-disconnector or the earthing-switch is in closed state.

In order to effectively block both manual and electric command of the switch-disconnector, a blocking mechanism shall be designed that acts by means of traction. This mechanism shall be situated in the bottom part of the enclosure and shall be activated and deactivated by means of an insulated stick applying a downward strength that doesn't exceed 200 N.

The manual command of the earthing-switches shall be designed in order to allow the application of a lock with an arc of 8 mm thickness in both positions on the manual command in order to block it.

**7.6.3 Forwarded manual command for switchgear without earthing-switches.**

The forwarded manual command shall be according to chapter 7.5.4 of this Standard.

**7.6.4 Direct manual command for switchgear without earthing-switches.**

The direct manual command shall be according to chapter 7.5.5 of this Standard.

**7.6.5 Electric command.**

The characteristics of the electric command shall be as specified in chapter 7.5.6 of this Standard.

**7.6.6 Voltage detecting and indicating system.**

The switchgear for cable lines with the earthing-switches shall be provided with a voltage detecting and indicating system according to IEC 62271-213 Standard. The systems shall be available for both sides of switchgear (line and load).

The part of the detector with the indicator and the testing point shall be placed into an enclosure intended for outdoor use. The enclosure shall have a fixing system for every type of pole on the ENEL DSOs.

The connection between the lower part of the switchgear and the enclosure with the indicator shall be designed for a distance up to 6 m.



**Material specification code: GRI-GRI-MAT-E&C-0038**

Version no. 1 dated 21/04/2023.

**Subject: GSCM003 MV POLE MOUNTED SWITCH-DISCONNECTORS**

**Application Areas**

Perimeter: *Global*

Staff Function: -

Service Function: -

Business Line: *Enel Grids*

## 7.7 TESTING

Tests are divided in:

- Type tests.
- Routine tests.
- Acceptance test

### 7.7.1 Type tests

The type tests are for the purpose of proving the ratings and characteristics of switchgear, their operating devices and their auxiliary equipment. Each individual type test or type test sequence shall be made on test objects in the condition as required for service (filled with the specified types and quantities of gas), with their operating devices and auxiliary equipment.

#### 7.7.1.1 Visual inspection

The switch-disconnector shall be checked to verify compliance with the drawings included in type A documentation approved.

All the nameplate data and markings defined in chapters 7.4.8 and 7.4.11 of this Standard shall be clearly shown on the switchgear.

#### 7.7.1.2 Dielectric tests

Dielectric test shall be done according to chapter 7.2 of IEC 62271-200, including wet tests for external insulation (only for bare conductors switch-disconnector). The standard wet test procedure given in IEC 60060-1:2010 shall be followed.

The test includes:

- lightning impulse voltage tests (chapter 7.2.7.3 of IEC 62271-200)
- power-frequency voltage tests (chapter 7.2.7.2 of IEC 62271-200)



**Material specification code: GRI-GRI-MAT-E&C-0038**

Version no. 1 dated 21/04/2023.

**Subject: GSCM003 MV POLE MOUNTED SWITCH-DISCONNECTORS****Application Areas**Perimeter: *Global*

Staff Function: -

Service Function: -

Business Line: *Enel Grids*

- partial discharge tests (chapter 7.2.10 of IEC 62271-200)
- test on auxiliary and control circuits (chapter 7.2.11 of IEC 62271-200)

**7.7.1.3 Resistance measurement**

Resistance measurement shall be done according to chapter 7.4 of IEC 62271-200.

**7.7.1.4 Continuous current tests**

Continuous current test shall be done according to chapter 7.5 of IEC 62271-200.

**7.7.1.5 Short-time withstand current and peak withstand current tests**

The tests shall be done according to chapter 7.6 of IEC 62271-200.

**7.7.1.6 Verification of the protection**

The test shall done be according to chapter 7.7 of IEC 62271-200.

**7.7.1.7 Tightness tests**

The test shall be done according to chapter 7.8 of IEC 62271-200 for sealed pressure systems. Qm test (refer to IEC 60068-2-17) shall be the chosen method for this test.

**7.7.1.8 Electromagnetic compatibility tests (EMC).**

The tests shall be done according to chapter 7.9 of IEC 62271-200

**7.7.1.9 Additional test on auxiliary and control circuits.**

The test shall done be according to chapter 7.10 of IEC 62271-200

**7.7.1.10 Verification of making and breaking capacities.**

The tests shall done be according to chapter 7.101 of IEC 62271-200



**Material specification code: GRI-GRI-MAT-E&C-0038**

Version no. 1 dated 21/04/2023.

**Subject: GSCM003 MV POLE MOUNTED SWITCH-DISCONNECTORS**

**Application Areas**

Perimeter: *Global*

Staff Function: -

Service Function: -

Business Line: *Enel Grids*

**7.7.1.11 Mechanical operation tests.**

The tests shall done be according to chapter 7.102 of IEC 62271-200

**7.7.1.12 Pressure withstand test for gas-filled compartments.**

The tests shall done be according to chapter 7.103 of IEC 62271-200

**7.7.1.13 Internal arc test.**

The test shall done be according to IEC 62271-214 considering a minimum approach distance of 3 m.

**7.7.1.14 Tests for bushings (bare conductors switchgear).**

The insulated bushings shall pass all the tests of the standard IEC 60137, including the Tracking and erosion test according to IEC 62217.

The type test intended to prove the characteristics required in chapter 7.5.1 of this technical specification shall be included in the TCA Dossier.

**7.7.1.15 Additional type tests for Chile, Colombia and Peru.**

The manufacturer shall elaborate a report to demonstrate the required seismic qualification level according to the Standards indicated in chapter 7.2.2.

**7.7.2 Particular type tests for switch-disconnector and earthing-switches.**

**7.7.2.1 Mechanical and environmental tests for switch-disconnector.**

The test shall done be according to chapter 7.102 of IEC 62271-103. The test shall be done considering the temperature limits required in the service conditions requirements of this standard.

The tests shall be done considering both the manual command and the electrical command.

At the beginning of the type tests, the mechanical characteristics of the switch-disconnector shall be established. The mechanical characteristics shall be produced during a no-load test made with one single



**Material specification code: GRI-GRI-MAT-E&C-0038**

Version no. 1 dated 21/04/2023.

**Subject: GSCM003 MV POLE MOUNTED SWITCH-DISCONNECTORS**

**Application Areas**

Perimeter: *Global*

Staff Function: -

Service Function: -

Business Line: *Enel Grids*

C operation and one single O operation at rated supply voltage of operating device and rated functional pressure for operation.

The opening and closing characteristics recorded in the reference no-load test shall be used as reference closing and reference opening characteristics with the tolerances given by the manufacturer.

The operating times, consumption of motorization and maximum forces for manual operation shall be recorded and used for reference in routine and acceptance tests. The manufacturer shall include in the TCA dossier these values along with the tolerances allowed for the correct operation of the switchgear.

**7.7.2.2 Operating and mechanical endurance test for earthing-switches.**

The test shall done be according to chapter 7.102 of IEC 62271-102

**7.7.2.3 Test to verify the proper functioning of the position-indicating devices.**

The test shall done be according to chapter 7.105 of IEC 62271-102

**7.7.2.4 Low- and high-temperature tests for earthing switches.**

The test shall done be according to chapter 7.104 of IEC 62271-102

**7.7.3 Routine tests.**

The routine tests are for the purpose of revealing faults in material or construction. They do not impair the properties and reliability of a test object. The routine tests shall be made at the manufacturer's works on each apparatus manufactured.

**7.7.3.1 Dielectric test on the main circuit.**

The test shall done be according to chapter 8.2 of IEC 62271-200

**Material specification code: GRI-GRI-MAT-E&C-0038**

Version no. 1 dated 21/04/2023.

**Subject: GSCM003 MV POLE MOUNTED SWITCH-DISCONNECTORS****Application Areas**Perimeter: *Global*

Staff Function: -

Service Function: -

Business Line: *Enel Grids***7.7.3.2 Tests on auxiliary and control circuits.**

The tests shall done be according to chapter 8.3 of IEC 62271-200

**7.7.3.3 Measurement of the resistance of the main circuit.**

The measurement shall done be according to chapter 8.4 of IEC 62271-200

**7.7.3.4 Tightness test.**

The test shall done be according to chapter 8.5 of IEC 62271-200

**7.7.3.5 Design and visual checks.**

The test shall done be according to chapter 8.6 of IEC 62271-200

**7.7.3.6 Mechanical operations tests.**

The tests shall done be according to chapter 8.102 of IEC 62271-200

The opening and closing characteristics recorded in the reference no-load test shall be used as reference closing and reference opening characteristics. The value of the operating times, consumption of motorization and maximum forces for manual operation shall be in a range of the reference values obtained in the type test with tolerances given by the manufacturer.

**7.7.3.7 Pressure tests of gas-filled compartments.**

The tests shall done be according to chapter 8.103 of IEC 62271-200

**7.7.4 Acceptance tests.**

Acceptance tests will be considered as those indicated in chapter 7.7.3 of this standard (routine tests) plus those indicated below:



**Material specification code: GRI-GRI-MAT-E&C-0038**

Version no. 1 dated 21/04/2023.

**Subject: GSCM003 MV POLE MOUNTED SWITCH-DISCONNECTORS**

**Application Areas**

Perimeter: *Global*

Staff Function: -

Service Function: -

Business Line: *Enel Grids*

1. Visual inspection (will consist of verifying the external appearance of the switchgear and its components, finish, homogeneity of the supply units and compliance with the designs of the material offered.
2. Operation test with the control: Review of the sequences, interlocks, simultaneity of contacts and locks as indicated by the manufacturer's manual.

The number of samples to be subjected to acceptance tests shall be determined statistically according to the indications given in Table ISO 2859-1 using:

- Sample plan: simple reduced
- Current testing at Level II
- Acceptable Quality Level (AQL): 0.65%

In the case of negative results of the test, Enel reserves the right, for subsequent tests, to use test plans that involve a larger sample than the previous test, starting from the simple ordinary type (statistical testing where the AQL = 0.65%) up to 100% of the batch.

## 7.8 CONDITIONS OF SUPPLY

Each unit of GSCM003 switchgear shall be supplied with:

- Switch-disconnector with characteristics indicated in chapters 7.3, 7.4, 7.5 and 7.6 of this Standard.
- Installation, operation and maintenance manual in the language of the Country in which the switchgear has to be delivered.
- Manual with procedures to be adopted for storage, after factory test and transportation.
- Connection cable for connecting the switch-disconnector and the UP.
- Support bracket

The insulators and the bushings shall be opportunely protected to safeguard them from impacts that may damage them during the transportation.

Outside of the box containing the switch-disconnector, it shall be clearly written:

- name of the Distribution Company.
- name of the supplier.
- description of the product.



**Material specification code: GRI-GRI-MAT-E&C-0038**

Version no. 1 dated 21/04/2023.

**Subject: GSCM003 MV POLE MOUNTED SWITCH-DISCONNECTORS**

**Application Areas**

Perimeter: *Global*

Staff Function: -

Service Function: -

Business Line: *Enel Grids*

- code assigned by the supplier.
- type code and serial number of the Distribution Company.
- gross weight.

In case of switchgears for Colombia, the manufacturer shall include the mandatory RETIE certificate in the TCA dossier.

**Material specification code: GRI-GRI-MAT-E&C-0038**

Version no. 1 dated 21/04/2023.

**Subject: GSCM003 MV POLE MOUNTED SWITCH-DISCONNECTORS**

**Application Areas**

Perimeter: *Global*

Staff Function: -

Service Function: -

Business Line: *Enel Grids*

## 8 ANNEX A. MOTORIZATION CONNECTION

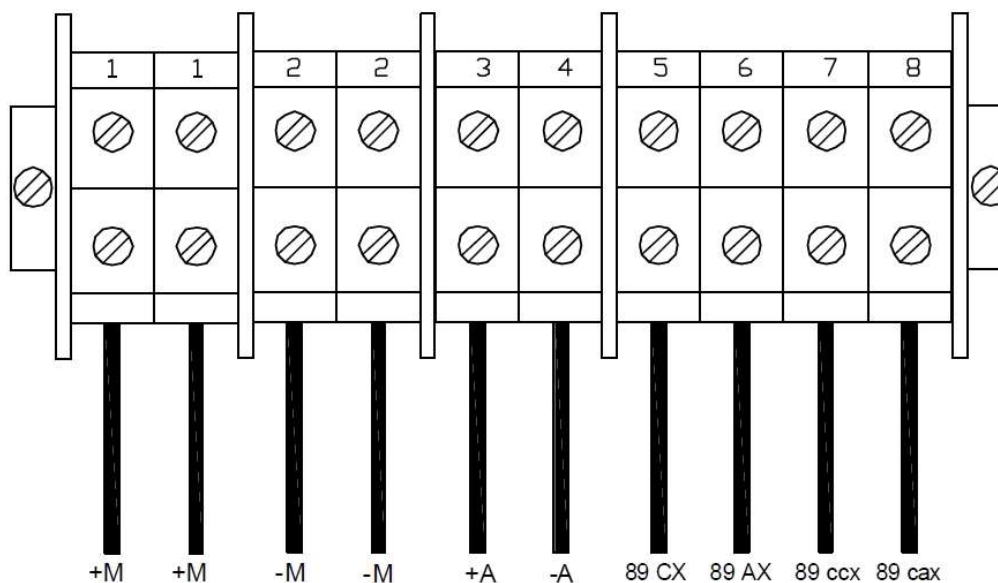

S-D	Function		Peripheral Unit
1	+M	Motor power supply (+24 V <sub>DC</sub> )	1
1	+M	Motor power supply (+24 V <sub>DC</sub> )	1
2	-M	Motor power supply (-24 V <sub>DC</sub> )	2
2	-M	Motor power supply (-24 V <sub>DC</sub> )	2
3	+A	Commands power supply (+24 V <sub>DC</sub> )	3
4	-A	Commands power supply (-24 V <sub>DC</sub> )	4
5	89CX	Closing command	5
6	89AX	Opening command	6
7	89ccx	Signal closing position switch-disconnector	7
8	89cax	Signal opening position switch-disconnector	8

**Table 11. Connection between switch-disconnector and Peripheral Unit**



**Material specification code: GRI-GRI-MAT-E&C-0038**

Version no. 1 dated 21/04/2023.

**Subject: GSCM003 MV POLE MOUNTED SWITCH-DISCONNECTORS**

**Application Areas**

Perimeter: *Global*

Staff Function: -

Service Function: -

Business Line: *Enel Grids*

## 9 ANNEX B. CHARACTERISTICS OF SWITCHGEAR SUPPORT

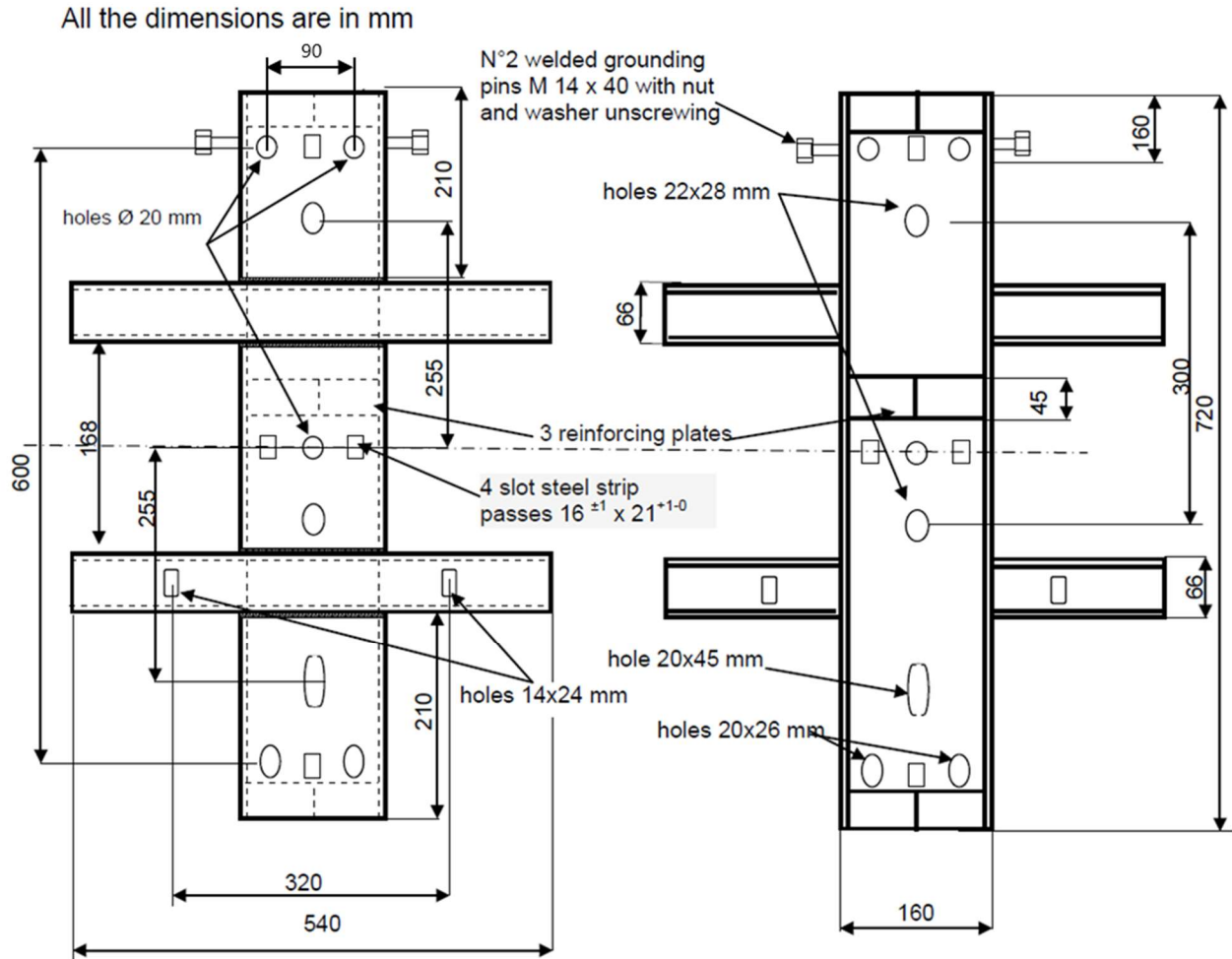

Plate thickness of the profiles: 4 mm

S235JR steel galvanized according to UNI EN ISO 1461: 2009





**Material specification code: GRI-GRI-MAT-E&C-0038**

Version no. 1 dated 21/04/2023.

**Subject: GSCM003 MV POLE MOUNTED SWITCH-DISCONNECTORS**

**Application Areas**

Perimeter: *Global*

Staff Function: -

Service Function: -

Business Line: *Enel Grids*

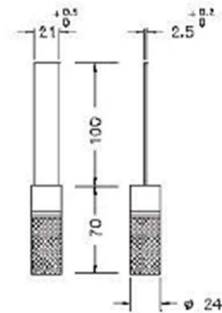

Caliber for slot steel strip passes

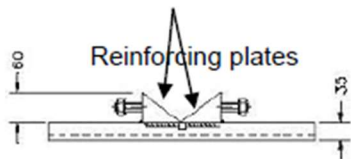

for this particular, see the table of switch-disconnector to install

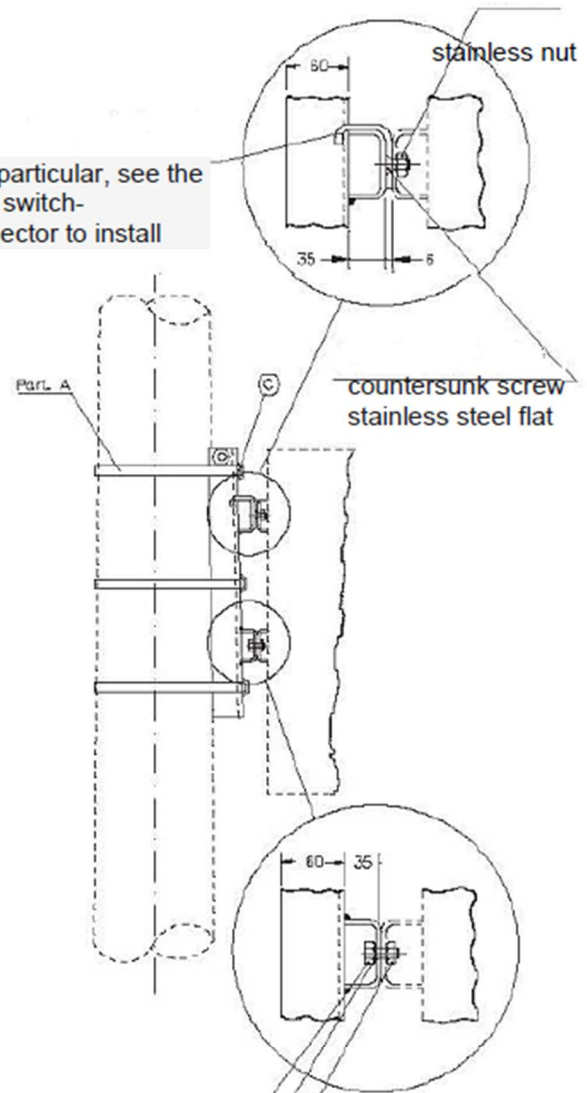

hexagon bolt M 12x30  
stainless steel for hole Ø 14

flat washer stainless steel  
thickness 4 mm Ø 12,5 mm

Nut M12 stainless  
steel

**Material specification code: GRI-GRI-MAT-E&C-0038**

Version no. 1 dated 21/04/2023.

**Subject: GSCM003 MV POLE MOUNTED SWITCH-DISCONNECTORS**
**Application Areas**

 Perimeter: *Global*

Staff Function: -

Service Function: -

 Business Line: *Enel Grids*
**TESTS**
**GENERAL**

Tests are classified into:

- Type tests
- Acceptance tests

**TYPE TESTS**

1. **Visual inspection** : checking erroneous characteristics of the support; not allowed sharp corners, points and malformations and welding should be performed with continuous welding bead and minimum thickness not less than the thinnest of the elements to be connected according to ISO 3834.
2. **Checking dimensions** : Check if tolerances are no exceed, direct verification by means tools of the support dimensions.
3. **Check of the thickness of the galvanizing** :in according to ISO 1461:2009
4. **Material testing**: It must verify that the materials used shall be those contained in this specific.

For all tests negative results are not allowed.

**ACCEPTANCE TESTS**

1. **Visual inspection** : checking erroneous characteristics of the support; not allowed sharp corners, points and malformations and welding should be performed with continuous seam welding and minimum thickness not less than the slim of the elements to be connected according to ISO 3834
2. **Checking dimensions** : Check if tolerances are no exceed, direct verification by means tools of the support dimensions.
3. **Check of the thickness of the galvanizing** : in according to ISO 1461:2009
4. **Material testing**: It must be verified that the materials used shall be those contained in this specific through mechanical tensile test according to ISO 6892-1:2009.

All acceptance tests must verify in according to ISO 2859 "Sampling procedures for inspection by attributes.

For all tests negative results are not allowed.

**Material specification code: GRI-GRI-MAT-E&C-0038**

Version no. 1 dated 21/04/2023.

**Subject: GSCM003 MV POLE MOUNTED SWITCH-DISCONNECTORS**
**Application Areas**
Perimeter: *Global*

Staff Function: -

Service Function: -

Business Line: *Enel Grids*
**10 ANNEX C. GENERAL DIMENSIONS**

The dimensions are valid for horizontally oriented switchgear. For vertically oriented switchgear, the dimensions shall be accorded between ENEL and the manufacturer.

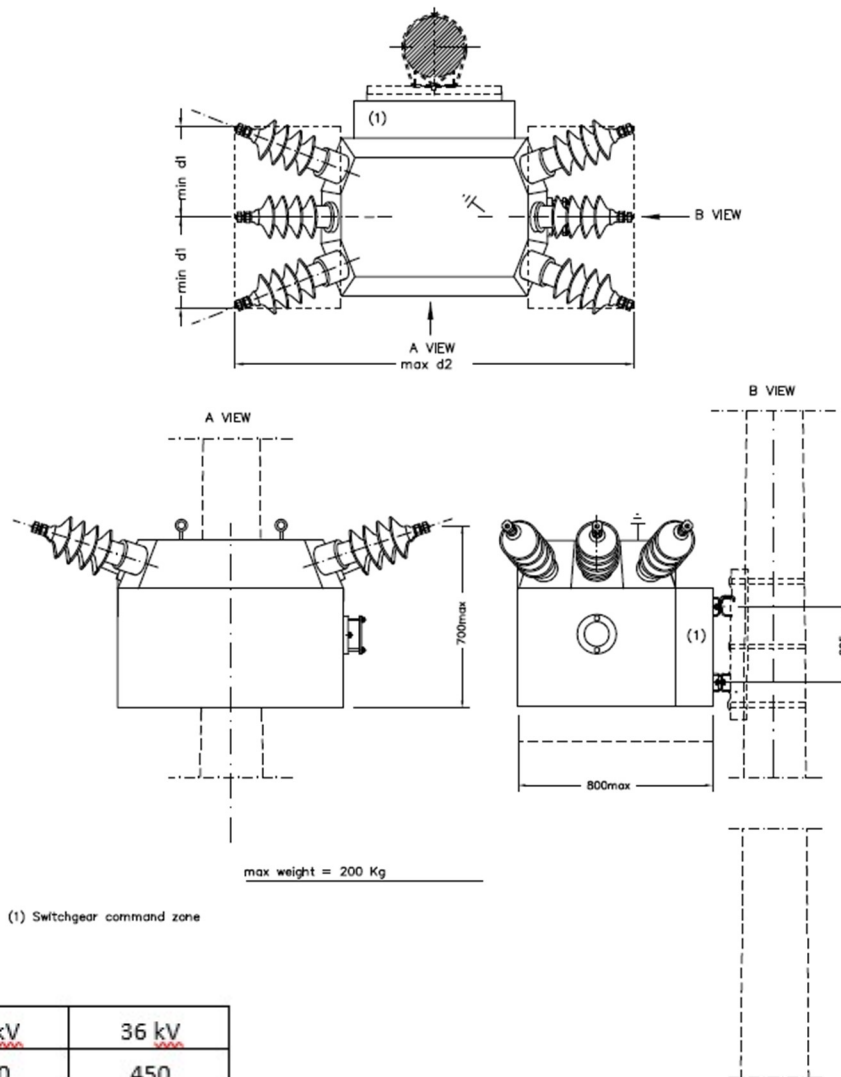
**SWITCH-DISCONNECTOR FOR BARE CONDUCTOR LINES**

	24 kV <small>200kV</small>	36 kV <small>300kV</small>
d1 (mm)	350	450
d2 (mm)	1550	1860

The distance d1 is measured over the projection into a horizontal plane below the bushings



**Material specification code: GRI-GRI-MAT-E&C-0038**

Version no. 1 dated 21/04/2023.

**Subject: GSCM003 MV POLE MOUNTED SWITCH-DISCONNECTORS**

**Application Areas**

Perimeter: *Global*

Staff Function: -

Service Function: -

Business Line: *Enel Grids*

**SWITCH-DISCONNECTOR FOR CABLE LINES**

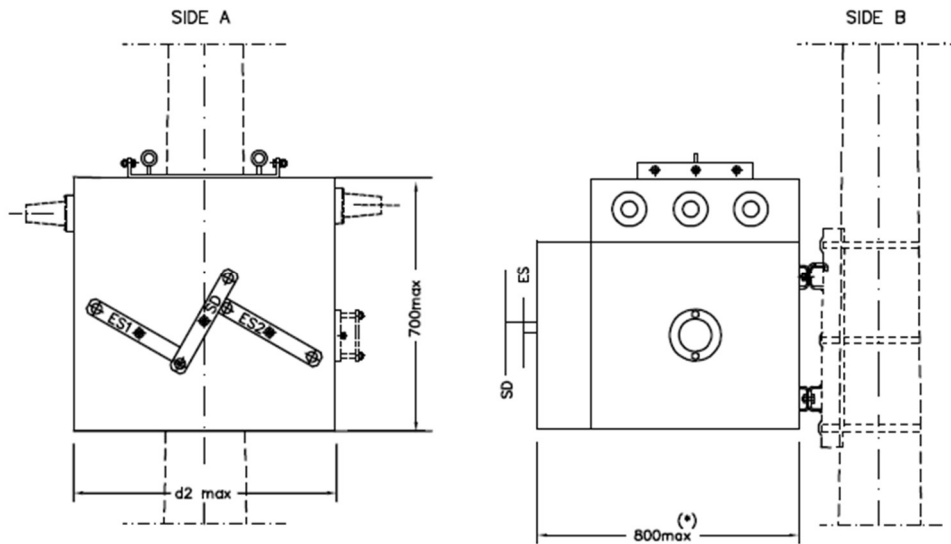
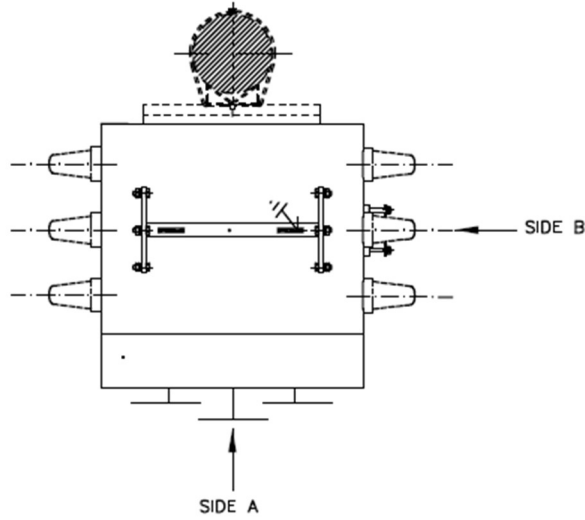

(\*) excluding overpressure valve and levers

	24 kV	36 kV
d2 (mm)	800	1100